

ENGLISH

User and Service Manual

EZ Rider

Upright Wheelchair



READ INSTRUCTIONS BEFORE USING

SAVE THIS BOOK FOR FUTURE REFERENCE

 **Convaid**

Customer Service Support

Toll Free: 1-844-US-Mobility (844-876-6245)
Phone: (310) 618-0111
Fax: (310) 618-8811
Email: sales@convoid.com
International Email: international@convoid.com
Website: www.convoid.com

Technical assistance or repair information hours are:
Monday-Friday, 6 a.m. to 4:30 p.m. PST

Before Calling:

Please fill in the following. Customer Service will be able to help you more quickly if the information indicated below is readily available.

Serial number of chair: _____

Model of chair: _____

Date purchased: _____

Notice:

The information contained in this document is subject to change without notice.

No part of this document may be photocopied, reproduced, transmitted, transcribed, stored in a retrieval system or translated to another language or computer language, in any form or by any means, electronic, mechanical, magnetic, optical, chemical, manual or otherwise without the prior written consent of Convoid.

Use only Convoid accessories and parts on Convoid products. Convoid parts are not interchangeable with other manufacturers' products. Replace any work parts immediately.

Table of Contents

Product Overview

Definition of Symbols.....	1
Warnings.....	3
EZ Rider Overview.....	6
Specifications.....	7

Setting Up

Contents in the Box.....	9
How To Remove Chair from Box.....	9
Preparing the Chair for Use.....	9
Tools Required.....	9
Unfolding EZ Rider Models	10
Folding.....	11
Locking.....	11
Lifting/Carrying.....	12

Fitting Guide

Seat Back Height.....	13
Seat Width.....	13
Seat Depth.....	14
Seat Depth Tube Replacement.....	14
Attaching Support Strap for Seat Extension Tubes.....	15
Two-Piece Seat.....	15

Wheels

Wheel Options.....	16
Quick Release Wheels.....	17
Anti-Shimmy Adjustment.....	17
Locking and Unlocking.....	18

Operating Instructions

Three-Point Positioning Belt	19
H-Harness with Padded Covers.....	20
Depth Adjustable Crotch Strap.....	20
Footplate Height Adjustment.....	21
Angle Adjustable Footplates.....	22
Footplate Depth Adjustment	23
Caster Locks.....	23
Calf Panel.....	23

Accessories

Swing-Away Lateral Support with Scoliosis Strap.....	24
Attaching Lateral Trunk Support Single Flap.....	25
Attaching Lateral Trunk Support Double Flap.....	26
Full Torso Swing-Away Support Vest.....	28
Lateral Thigh Support (Adductor).....	28
Medial Thigh Support (Abductor).....	28
Padded Headwings.....	29

Headrest Extension..... 29
Height Adjustable Flip-Up Armrests..... 30
Occi Headwing..... 30
5-Point Harness..... 31
Seat Cushions..... 33
Fitting..... 34
Caution..... 34
Headrest Cover (Canopy)..... 35
Heavy Duty Reinforced Upholstery..... 36
Reducer Seat Insert..... 36
Rear Anti-Tip Tubes..... 36
Utility Bag..... 37

Transit Models
Transit Option..... 38
Transit Mode Instructions..... 39
Recommended Clear Zones In Vehicle..... 41
Providing Clear Space & Padding..... 41
Proper Use of Equipment..... 42
Restraining the Wheelchair Occupant..... 45
Using Postural Belts & Supports..... 46
Trays & Other Wheelchair Components..... 47
WTORS Manufacturers..... 47

Miscellaneous
Fabric Removal..... 48
Adjustable Tension Back..... 49

Important Information
Maintenance, Operating & Safety Instructions..... 50
Warranty.....Back Cover

READ BEFORE USE

Read the user's guide completely before use and fully understand its content. Familiarize yourself with the handling and functions of the product before use and practice them. Any caregiver that is going to operate this chair should also read the user's guide in full.

You are responsible for the safety of the user. The safety of the user could be affected if you do not follow the instructions in this user's guide. Nevertheless, not all possible circumstances and unpredictable situations can be covered by this user's guide. Reason, care, and circumspection are not features of the product; they are required of persons who use the product. If instructions are not clear and further explanation is necessary, please contact your Convoid provider. If you do not follow all instructions and warnings, damage to the chair or serious injury may occur. The latest version of all instructions and product safety notice are available on the Convoid website www.convoid.com and can be printed in larger sizes. Additional video instructions are also available for reference purposes.

DEFINITION OF SYMBOLS

**WARNING!**

The word "WARNING" and/or the symbol shown above indicates practices that are unsafe or dangerous and could result in serious injury or death to the occupant of this chair or others.

**WARNING! READ USER'S GUIDE!**

Additional symbols are defined throughout this user's guide along with operating instructions.



This symbol indicates potential finger entrapment.



This symbol indicates correct lifting points for safe moving and handling.



This symbol indicates manufactured date.



This symbol indicates maximum user's weight.



This symbol indicates a wheelchair which cannot be used in motor vehicle as vehicle seat. This wheelchair does not comply with WC19 (RESNA WC-4:2012 or ISO7176-19:2008) and cannot be used as a vehicle seat to transport the user in a vehicle.



This symbol indicates a wheelchair which can be used in motor vehicle as a vehicle seat. This wheelchair complies with WC19 (RESNA WC-4:2012 and ISO7176-19:2008) and can be used as a vehicle seat to transport the user in a vehicle.



This symbol indicates the position of an anchor point when using a 4 -point tiedown system (WTORS) during transit.

CHOOSE THE RIGHT CHAIR & SAFETY OPTIONS

There are several options available to meet the needs of the wheelchair user. Make sure that your (and your health care provider's) choice of chair and other added options takes into account the user's comfort, positioning, physical limitations, and hazards that may be encountered during daily use. Operating the manual wheelchair outside of the recommendations provided by the manufacturer can lead to a dangerous situation.

The wheelchair is not suitable for jogging, running, skating or similar activities. Swiveling front wheels tend to wobble at higher speeds and can cause a sudden stop, and the wheelchair can tip over. Use the wheelchair only at regular walking speed. Under no circumstance should you let go of the push handle while pushing.

The durability of this product is five years when it is used with proper care and maintenance according to the user's guide.

General Warnings



WARNING: The operator/caregiver must read and understand this manual prior to operating this equipment. If you are unable to understand any part of this manual, contact your supplier for assistance.



WARNING: Please keep packaging material away from children. Plastic packaging presents danger of suffocation.



WARNING: The chair is only intended to carry one user at a time. Do not carry more than one user at a time.



WARNING: The weight capacity carried by the EZ Rider chair must never exceed the total weight capacity of the chair (maximum occupant size plus any items carried). When using the chair in transit, all accessories must be removed from the chair and secured separately.



WARNING: To avoid tipping, do not hang items from the push handle.



WARNING: To reduce the risk of an accident:

- ALWAYS carefully read the User's Guide and become comfortable with operating the chair.
- ALWAYS watch for obstacles and avoid them as often as possible.
- MAKE SURE that the chair operates properly. Repair any problems before use.
- ALWAYS verify that the quick release axles are locked so that the back wheels do not come off.
- ALWAYS secure the user into the chair during use.



WARNING: Pay particular attention when on slopes and inclines to prevent:

- The user from falling out of the chair.
- The chair from tipping over.
- The chair from rolling away.



WARNING: Do not go up or down stairs without the assistance of another person or with the user in the chair. If devices such as ramps or elevators are available, please use them. If they are not available, then the chair should be carried over the obstacle by two people without the user in the chair.



WARNING: Always secure user with belt first, before making any other adjustments.



WARNING: Before removing the user from the chair and before returning the user to the chair, always engage the wheel locks. Never remove or place user without engaging the wheel locks.



WARNING: Never leave the user unattended in the chair even when he/she is strapped in and the wheel locks are engaged.



WARNING: Do not stand on the foot support when getting into or out of the chair.



WARNING: When the user reaches for objects in front, to the side, or behind the chair, be sure that they do not lean out of the chair too far since a shift in the center of gravity might cause the chair to tilt or tip over.



WARNING: Positioning belts should never be used as a safety restraint device in a motor vehicle when transporting chair with occupant. An additional WC19 (ISO 7176-19) compliant automotive type seat belt is required when the chair is used in transport vehicles.



WARNING: Do not use the chair unless it has proper tire pressure (Front 36 psi/Rear 30 psi, 248kPa/200kPa, 2.5BAR/2.0BAR). Do not overinflate tires. Failure to follow these instructions may cause the tire to explode and cause harm. Tire size and maximum pressure are listed on the wheel.



WARNING: Ensure the wheels are installed properly. You will hear a “click” when wheel locks into place.



WARNING: Do not leave/store the chair in direct sun/heat over a long period of time. Check the temperature of the chair prior to usage.



WARNING: Removable accessories that can be removed without tools will not cause adverse effects on wheelchair.



WARNING: The EZ Rider could lose its flame-resistant characteristics when using aftermarket seating or cushions.



WARNING: For occupant safety, the seat belt should be used at all times.

- Do not leave user unattended.
- Do not strap user too tight.
- Straps should not interfere with breathing or circulation.
- Always apply wheel locks before letting go of the chair.
- If front edge of seat is at, or forward of, the point where tires touch the floor, avoid using front of seat tubes for support during entry or exit from chair to prevent tipping.
- Avoid using footplates for weight support during exit and entry of the chair.

EZ Rider Overview

One Piece Height Adjustable Push Handle



Chair Warning Label

Never leave occupant unattended. Failure to read and follow user guide instructions could result in serious injury. To obtain a replacement user's guide email sales@convaid.com or call 844-876-6245.

Serial Number Label



290 mm x 64 mm
Rear Solid Wheels

191 mm x 51mm
Front Solid Wheels

Removable Angle Adjustable Swing-Away Footplates

Transit Anchor (Option)

Transit Anchor
Logo Sticker



EZ RIDER SPECIFICATIONS (Millimeters)

Model Size	EZ 12	EZ 14	EZ 16	EZ 18
Seat Width	305	356	406	457
Seat Depth	229 - 356	279 - 406	305 - 432	368 - 495
Seat Back Height Regular	533	610	660	686
Seat Back Height Transit	483	559	610	635
Seat to Floor Height	483	508	508	546
Seat to Back Angle	100°	100°	100°	100°
Seat Angle	10°	10°	10°	10°
Armrest Height	114 - 172	152 - 210	140 - 229	172 - 254
Overall Height	965	978	1016	940
Overall Length	914	953	1105	1219
Overall Width	546	584	660	660
Folded Length	1130	1168	1219	1156
Folded Width	356	343	356	368
Folded Height	445	457	432	394
Pivot Width	1295	1372	1430	1374
Maximum Slope (for use of parking brake)	10°	10°	10°	10°
Seat to Footplate	76 - 508	76 - 533	76 - 559	76 - 559
Weight Capacity Regular	34 kg	45.5 kg	77 kg	113 kg
Weight Capacity Transit	30 kg	45.5 kg	77 kg	77 kg
Weight of Chair Δ	11 kg	14 kg	14 kg	13 kg
Push Handle Adjustment	749 - 1181	737 - 1194	711 - 1143	N/A
Material (Frame)	Steel / Aluminum			
Material (Plastic Parts)	Fiber glass strengthened polyamide			
Material (Cushion)	Fire-resistance foam*			
Material (Fabrics)	Fire-resistance nylon, polyester*			

*Resistance to ignition of upholstered parts complies to BS-EN 1021-1 and -2
 Δ Weight of chair is without front rigging

EZ Rider Product Line



EZ Rider



EZ Rider 18

Chair Set Up & Adjustment

Contents in the Box

List of items included in the box:

- Mobility base and seating module
- Set (pair) of rear wheels
- User's Guide
- Accessories as ordered
- 5/32" Allen wrench

How to Remove Chair from Box

1. Place box flat on the floor.
2. Verify that package is in good shape and that no damage has occurred during shipping.
3. Remove the chair from the packaging material.
4. Check to make sure that your order is complete.

Preparing the Chair for Use

Once you have all components as ordered, the directions for use in this User's Guide will guide you through the process of preparing the chair for use.

Convaid recommends the initial fitting, adjustments, and setup take place with the help of your Convaid Representative and/or Convaid Service Dealer. However, if the instructions contained in this user's guide are followed carefully, a caregiver or attendant will be able to set up and assemble the chair.

Tools Required

- 5/32" Allen wrench
- 7/16" Wrench
- 3/8" Wrench
- Phillips Screwdriver

Setting Up



Fig. 1

Unfolding EZ Rider Models

1. Undo locking bar.
2. Stand chair on front casters. Fig. 2
3. Grasp the one piece height adjustable push handle and push down on the opposite seat tube. Fig. 3
4. Press down firmly on seat tubes to ensure the chair is completely unfolded. Fig. 4
5. Lock rear lock brace. Push brace downward until it locks into place. Fig. 5 & 6
6. Engage wheel locks.



WARNING: Keep fingers free of folding mechanism.



Fig. 2



Fig. 3



Fig. 4



Fig. 5



Fig. 6

Folding

1. Flip footplates to the side.
2. Flip back armrests (if equipped).
3. Pull on locking pin on horizontal locking bar on the back of the chair. Fig. 7
4. While pulling on locking pin, pull upward on locking bar. Fig. 8
5. Grasp the one piece height adjustable push handle and pull up on the center of the seat. Fig. 9
6. Lay chair flat with seat facing upward. Push on seat tubes to complete fold.

Note: Always properly secure the EZ Rider in a safe location when transporting as cargo in vehicle.

WARNING: To prevent injury, keep hands clear of folding mechanism during folding.

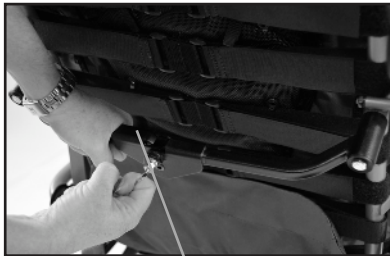

Fig. 7

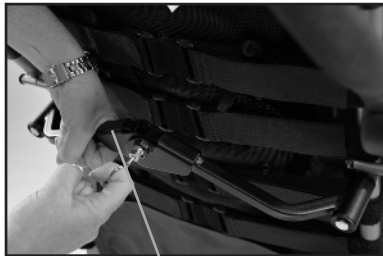

Fig. 8



Fig. 9



Locking

1. Rotate locking bar so it covers both front leg tubes. Fig. 10
2. The chair is now locked.



Fig. 10

Lifting/Carrying

1. To safely lift or carry the chair, hold it using both hands.
2. When chair is folded and locked: with one hand, hold by leg tube and with the other, hold by seat back tube. Fig. 11
3. When chair is open, hold leg tube with one hand and seat back tube with the other. Alternately, hold by leg tube and push handle. Fig. 12, 13 & 14



Fig. 11



Fig. 12

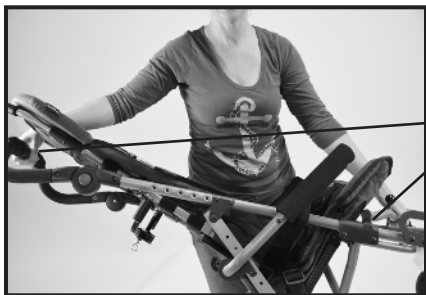

Fig. 13



Fig. 14



WARNING: Do not use armrest to lift the chair.

Fitting Guide

Convaid's lightweight, folding chairs are designed to be more than just a convenient chair. Order the correct size chair by first determining the user's height, weight and seating measurements. Properly fitted, Convaid chairs will provide years of comfortable use. As your child grows, refer back to this Fitting Guide to adjust the dimensions of the chair.

Correct seating and positioning encourages good posture, which in turn aids circulation, breathing and digestion. Please take the time to properly adjust the chair to fit the user. If the user is not correctly positioned, check the accessories section of this user's guide to see if one or more of our accessories would help to facilitate posture or consult a physical therapist. Improper seating can cause problems. Please consult a physical therapist or doctor for additional guidance.

Seat Back Height



Seat back height varies according to chair type and seat width. Headrest extensions are available when extra height is needed to support the head.

To determine the seat back height, measure from the seat to the top of the shoulder or the upper part of the head. Fig. 15

Fig. 15

Seat Width



Proper seat width enables the user to sit comfortably and prevents problems from developing. While user is seated on a flat surface, measure from hip to hip. Fig. 16

The user should have enough room to prevent hips and thighs from rubbing against the frame. However, the chair should not be too wide or the user will slide around and posture could be affected.

The seat width measurement for the EZ Rider is taken from the actual seat width.

Fig. 16

Seat Depth

Measure from the most posterior portion of the buttocks to the back of the knee. Subtract from that measurement 25 mm - 51 mm to allow adequate clearance between the seat and the back of the knee. Fig. 17



Fig. 17

To Change Seat Depth

1. Partially fold the chair to relieve fabric tension. Undo the Velcro® back panel of the two piece seat.
2. Grasp end of seat tube, depress spring button and move seat tube until spring button relocates into the desired hole.
3. Repeat for other side of seat. Fig. 18



Fig. 18

Seat Depth Tube Replacement

1. To change seat tubes or remove the seat tubes, press spring button. To install new seat tubes, press spring button and release when desired setting is achieved. Repeat for opposite side. Fig. 19 & 20
2. Reinstall fabric. Repeat for opposite side.

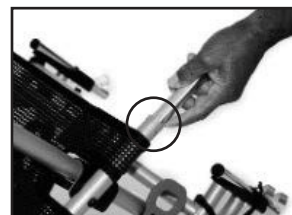

Fig. 19

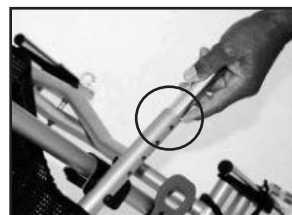

Fig. 20

Attaching Support Strap for Seat Extension Tubes

1. Remove seat upholstery. Fig. 21 & 22
2. Change and install seat depth tubes. Press spring button and move seat depth tube to desire setting. Fig. 23
3. Install support strap.
Note: Make sure rough, shiny side of strap is facing out. Fig. 24-27
4. Install Seat Upholstery. Fig. 28



Fig. 21



Fig. 22



Fig. 23



Fig. 24



Fig. 25



Fig. 26



Fig. 27



Fig. 28

FOR TEXTILENE UPHOLSTERY: (only applicable to EZ 14-18)

Make sure the seat depth tube inserts into the black web loop located on the inside corner of the textile upholstery. Fig. 29-31

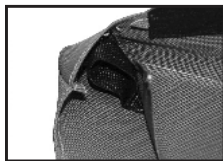

Fig. 29

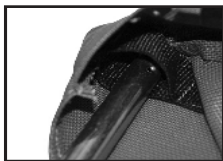

Fig. 30



Fig. 31

Note:

Do not use black web loop on the shortest adjustment of the small seat depth tubes.

Two-Piece Seat

The lower seat panel is attached to the back panel with Velcro®. It is used to take up slack in the seat panel after seat depth adjustments have been made. Fig. 32, 33 & 34

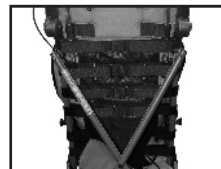

Fig. 32

<p>Excessive Velcro® overlap lifts seat fabric and pushes hips forward, creating poor posture and reducing effective seat depth.</p>	 <p>Wrong</p>	<p>Correct Velcro® adjustment provides room for hips, and makes greater use of seat depth.</p>	 <p>Right</p>
--	---	--	--

Fig. 33

Fig. 34

Wheels

Wheel Options

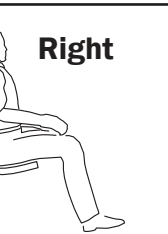
The EZ rider comes standard with solid front and rear tires. You can upgrade, replace or reorder tires at any time. You have the option of upgrading to pneumatic tires or re-ordering replacement standard solid tires. When ordering upgraded or replacement tires, please have the following information available:

Chair model and size (ex: EZ12)

Wheel size (ex: 7.5" x 2"/190mm x 51mm)

EZ-12/14/16

Pneumatic Tire Sizes (option)

7.5" x 2"/190 x 51 mm (front)

11.5" x 2.5"/290 x 60 mm (rear)

EZ-18

Pneumatic Tire Sizes (option)

8" x 2" /203mm x 51mm (front)

12.5" x 2" /318mm x 51mm (rear)



Fig. 35

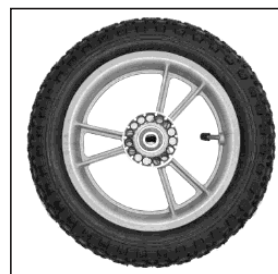

Fig. 36



WARNING: Do not use the chair unless it has proper tire pressure. (Front 36 psi/Rear 30 psi, 248kPa/200kPa, 2.5BAR/2.0BAR) Do not overinflate the tires. Failure to follow these instructions may cause the tire to explode and cause harm.

Quick Release Wheels

Tire Removal:

1. To remove, press down and hold the Rear Wheel Locking Pin. Grasp wheel and pull. Fig. 37 & 38
2. No tools are required to remove tire. Fig. 39



Fig. 37

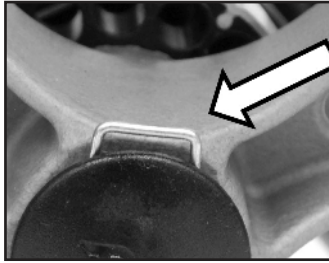

Fig. 38 Rear Wheel Locking Pin



Fig. 39

⚠ WARNING: Ensure the wheels are installed properly. You will hear a “click” when wheel locks into place.

Tire Installation:

1. To install, slide wheel onto rear axle and push with ball of hand until it clicks into place. Fig. 40 & 41



Fig. 40



Fig. 41

Anti-Shimmy Adjustment

If the front wheels develop a shimmy, use a wrench to tighten the stem nut. Adjust the stem nut clockwise until the shimmy disappears. Fig. 42

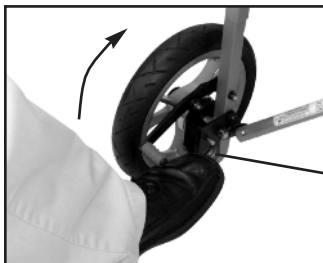

Fig. 42

Locking and Unlocking

Convaid manufactures two types of wheel locks: hand operated and foot operated. Check to see which type of wheel locks are on your chair.

Foot Operated Wheel Locks



To lock:
Lift upward
on wheel lock.



To release lock:
Press downward
on wheel lock.

Fig. 43

Fig. 44



WARNING: Proper care and maintenance must be taken to ensure proper function of the foot operated brakes.



WARNING: When operating the wheel lock, do not use excessive force to engage the locks with your foot. Only light pressure is needed to fully engage the locks.



WARNING: Teflon™ spray should be applied to brake components weekly to ensure proper operations.



WARNING: Excessive force or poor maintenance will cause premature failure for foot operated locks.

Operating Instructions

Three-Point Positioning Belt

Adjust the belt so the user stays securely in position. The quick release buckle is attached to the crotch strap, and joins the crotch strap to both belts.

To Buckle:

Slip the metal clasps on the belt strap into the sides of the buckle. Fig. 45

To Release:

Press the grey button on the buckle and pull out the clasps. Fig. 45



Fig. 45



WARNING: Always secure user with belt first, before making any other adjustments.

H-Harness with Padded Covers

H-harness shoulder straps help the user retain upright trunk position. To adjust, insert the bolt at the end of the strap through the grommet hole in the seat back. Grommet choice should be level with or higher than the top of the shoulders. Choose a hole that will keep the user secure without the strap rubbing against the face or neck. Secure the strap with the threaded knob. Fig. 46 & 47

Shoulder pads for the H-harness are standard. The pads come equipped with a snap buckle for easy attachment. Fig. 48



Fig. 46



Fig. 47



Fig. 48

Depth Adjustable Crotch Strap

The crotch strap can be adjusted by threading the strap through the desired slot. Fig. 49



Fig. 49

Footplate Height Adjustment

Seat-to-footplate height is measured from the back of the knee to the bottom of the heel. Feet or heels should rest comfortably on top of footplate. Fig. 50

All Convaid footplates are height adjustable.

Footplates swing away for access or folding.

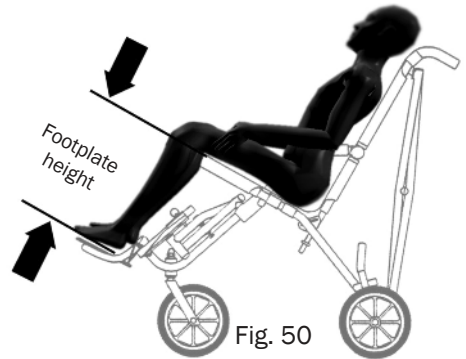

Fig. 50



Fig. 51

Pull on ring to remove detent pin holding footplate in place. Move footplate up or down, realign holes and replace pin through holes in tube. Fig. 51

Additional Footplate Height Adjustment:

In the event that the footplate height adjustment described above is inadequate, additional adjustments can be made.

1. Pull out detent pin and remove the footplate extension tube from the frame. Fig. 52
2. Press the spring button, then pull the footplate assembly apart. Fig. 53
3. Insert the footplate into the opposite end of the footplate extension and reassemble. Fig. 54



Fig. 52



Fig. 53



Fig. 54

For Additional Range:

4. Using a 5/32" Allen wrench (included), remove both bolts from the housing bracket on the mobility base. Flip the bracket upside down and replace bolts. Fig. 55 & 56
5. Return the footplate extension tube to the housing bracket and secure with detent pin. Fig. 57



Fig. 55

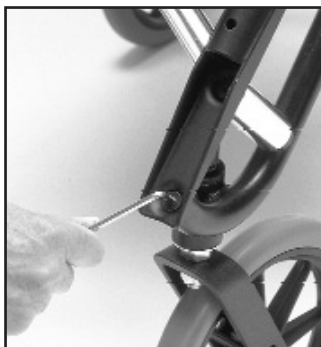

Fig. 56



Fig. 57

Angle Adjustable Footplates

Angle adjustable footplates can be moved before and after, sideways, and rotated vertically and horizontally. To adjust the angle, loosen the bolts on the footplate and move to desired position. Retighten the bolts. Fig. 58-62



Fig. 58

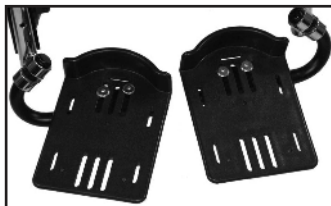

Fig. 59

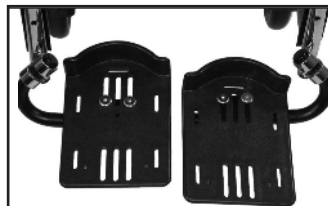

Fig. 60



Fig. 61



Fig. 62

Footplate Depth Adjustment

All EZ Rider chairs offer adjustable footplate depth. Use the 5/32" Allen wrench to loosen the two bolts located on the top of the footplate. Slide footplate forward or rearward to desired depth. Retighten bolts. Fig. 63



Fig. 63

Caster Locks

Caster locks hold the swivel wheels in a forward facing position to prevent the wheels from turning side to side. (For 5mm wide tires only) Fig. 64



Fig. 64

Calf Panel

Calf Panel provides support to the lower legs to give additional comfort, support and pressure relief. Fig. 65



Fig. 65

Accessories

Convaid offers a wide variety of accessories to help properly position the user.

Note: Convaid's chairs provide a semi-contour fit around the body. The user must be fitted correctly into the chair to achieve optimal posture and comfort.

Swing-Away Lateral Support with Scoliosis Strap

Single Flap:

Adjustable trunk support stabilizes the trunk and maintains midline positioning. It can be pulled to one side for scoliosis correction if used with scoliosis strap. Scoliosis strap comes standard with all trunk supports. Fig. 66

The trunk support is attached to the chair with straps that wrap behind the seat back and connect with Velcro®. Fig. 67

Support is achieved by pulling each triangular flap toward the appropriate side, then securing it by wrapping the strap around the frame and attaching with Velcro®. The two flaps can also be wrapped around the child's torso and joined in the middle.



Fig. 66

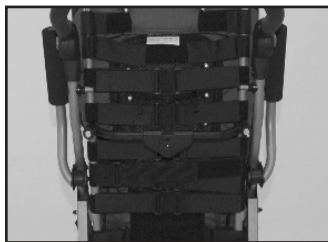

Fig. 67

Double Flap:

One set of triangular flaps locates the midline positioning. The second set of flaps wrap around the trunk for stabilization. The scoliosis strap can be used to pull the torso to either side. Fig. 68



Fig. 68

Attaching Lateral Trunk Support Single Flap

1. Attach the Lateral Trunk Support to the chair by wrapping the two rear straps around the back of the chair and securing with Velcro®.
2. Attach the single flap, by wrapping the strap on the left flap around the side tubing of the frame, and securing with Velcro® (repeat steps on opposite side)
3. Thread the scoliosis strap through the plastic loop on the left flap, back through the plastic loop on the opposite end of the strap, and pull tight.
4. Bring the scoliosis strap across the chest, thread it through the plastic loop on opposite flap, and fasten with Velcro®.

Note: The Lateral Trunk Support Single Flap can be used to support either the left or right side of the trunk.

- To support the right side of the trunk, attach the support to the chair with the double-sided Velcro® strap on the left side. Detach the strap on the right flap from the tubing, and tighten scoliosis strap until desired trunk positioning is obtained.
- To support the left side of the trunk, attach the support to the chair with the double-sided Velcro® strap on the right side. Detach the strap on the left flap from the tubing, and tighten scoliosis strap until desired trunk positioning is obtained.



Fig. 69

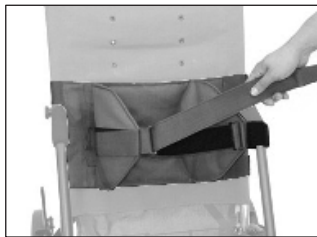

Fig. 70



Fig. 71

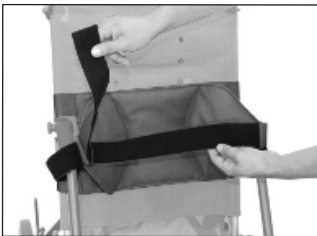

Fig. 73

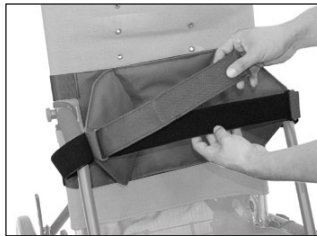

Fig. 74

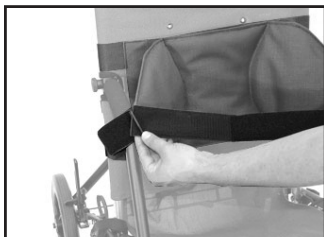

Fig. 75



Fig. 76



Fig. 77

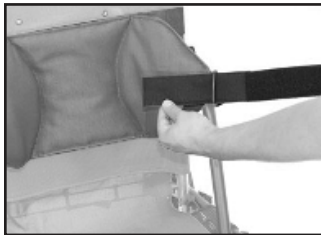

Fig. 78



Fig. 79

Attaching Lateral Trunk Support Double Flap

The Double Flap Lateral Trunk Support brings the trunk to midline position.

- The Inner flaps mobilize the trunk.
 - The Outer flaps centralize the trunk and keep the arms in the front of the chair.
 - The Scoliosis strap aligns the spine.
1. Attach the Lateral Trunk Support to the chair by wrapping the two rear straps around the back of the chair and securing with Velcro®.
 2. To attach the double flap, wrap the strap on the left hand outer flap around the side tubing of the frame and secure with Velcro®.
 3. Thread the strap on the left-hand inner flap into the plastic loop on the outer flap working from front to back.
 4. Adjust and secure strap. (Repeat steps 3 and 4 on right-hand flap.)
 5. Bring the long scoliosis strap through the plastic loop on the inner flap on the right hand side and across the chest.
 6. Thread the strap through the plastic loop on the inner flap on the left hand side.
 7. Fasten the strap with Velcro®.
 8. If additional tightness is desired, pull the scoliosis strap further and Velcro® it beyond the inner flap.

Note: The Lateral Trunk Support Double Flap can be used to support either the left or right side of the trunk.

- To support the right side of the trunk, attach the Support to the chair with the double-sided Velcro® strap on the right.
- To support the left side of the trunk, attach the Support to the chair with the double-sided Velcro® strap on the left.



Fig. 80



Fig. 81



Fig. 82

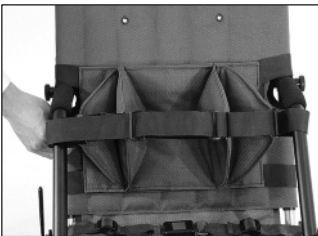

Fig. 83



Fig. 84

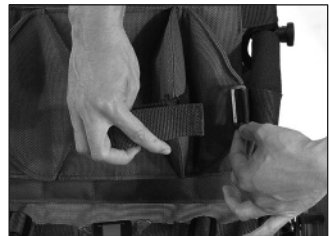

Fig. 85



Fig. 86



Fig. 87



Fig. 88

Full Torso Swing-Away Support Vest

An adjustable support vest keeps the user in place comfortably and securely. It helps to maintain midline seating position and prevents forward slumping. The vest is attached to the chair with straps that wrap around the seat back and connect with Velcro®, and shoulder straps that screw into the seat back. Adjust the side straps for proper fit. Fig. 89



Fig. 89

Lateral Thigh Support (Adductor)

Pulls thighs together, improving hip alignment and stabilizing seating position. The degree of adduction can be varied and can favor one side. Fold the adductor flaps over the thighs, wrap the straps under and around the armrest tube and attach with buckle. Fig. 90

The adductor is attached with screws at the end of the seat tubes.



Fig. 90

Medial Thigh Support (Abductor)

Separates the thighs to improve hip alignment and stabilize sitting posture. Degree of abduction can be varied and can favor one side. The abductor flaps wrap over the user's thighs from the inside to the outside. The straps buckle around the seat tube or the armrest. They can also be wrapped around the armrest tube twice for high tone children. Fig. 91

The abductor is attached with screws at the end of the seat tubes.



Fig. 91

Padded Headwings

Adjustable padded headwings provide soft foam support for midline positioning. (Fig. 92). The padded headwings can be attached at any height by wrapping the Velcro® straps around the frame and attaching at the back of the chair. Secure headwings by tying laces through the grommet holes in the back of the seat fabric or headrest extension. Fig. 93



Fig. 92



Fig. 93

Headrest Extension

The headrest extension fits easily into the sockets on the seat back. Fold chair slightly. Move rubber grommets on the mounting posts to adjust the height of the seat back extension. Fig. 94 & 95

Note: To reduce the possibility of injury, the headrest extension must be used with transit models.



Fig. 94



Fig. 95

Height Adjustable Flip-Up Armrests

The height adjustable flip up armrests provide added support and positioning. The armrests flip up out of the way for easy access into the chair, and adjust in height for added comfort. Fig. 96

To attach or adjust the height of the armrests, remove the two screws from each bracket with a 5/32" Allen wrench, adjust the bracket to the desired height, and reinsert the screws. Fig. 97



Fig. 96

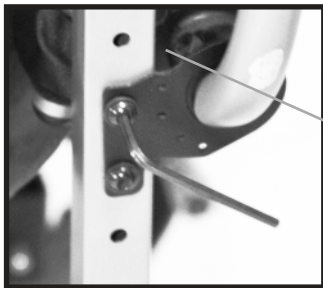

Fig. 97



WARNING: Do not use armrest to lift the chair.

Occi Headwing

Occi Headwing supports and positions the head at the occipital area. This headrest provides added comfort, allows side to side head movement without obstruction, and does not block the individual's ears and line of vision. Fig. 98

The Occi headwing can be attached at any height. Secure headwing by tying laces through the grommet holes at the back of the seat fabric or headrest extension.

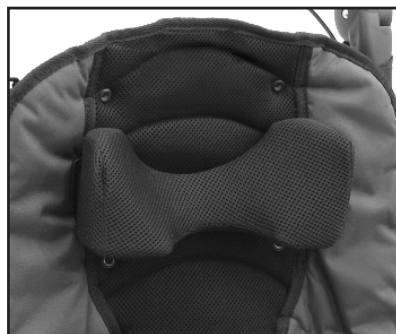

Fig. 98

5-Point Harness

Adjusting The Straps

1. Release the Rear Lock Brace by lifting up on the center of the brace. Fig. 99
2. Press in the silver snap button on the Rear Lock Brace. Fig. 100 & 101
3. Pull the lock brace off of the housing. Fig. 102
4. Pull shoulder strap through the upholstery, reposition to the desired height, and reinsert it back through the seat upholstery. Fig. 103
5. Slide the shoulder harness loop on to the Rear Lock Brace. Fig. 104
6. Release the Rear Lock Brace by lifting up on the center of the brace. Fig. 99
7. Reinsert the Lock Brace onto the housing by pushing it with the palm of your hand. Fig. 105 & 106
8. Lock the Rear Lock Brace by pressing down on the Rear Lock Brace. Fig. 107

Note: The shoulder straps should be positioned in slots that are slightly above the shoulders of the child, and as the child grows, they should be moved to maintain a height above the shoulder level.

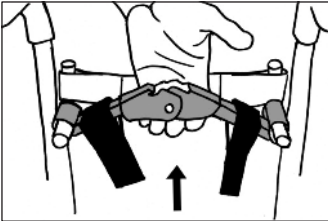

Fig. 99

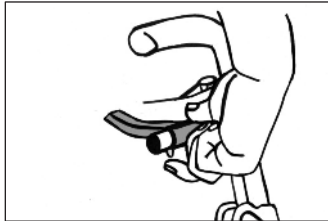

Fig. 100

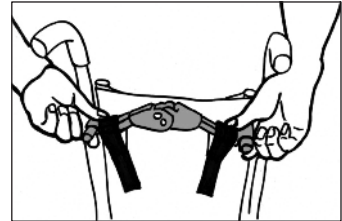

Fig. 101

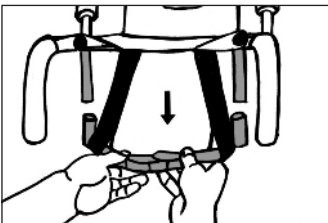

Fig. 102

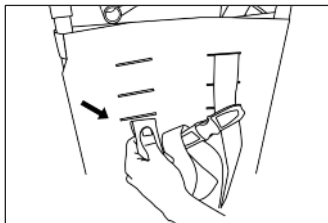

Fig. 103

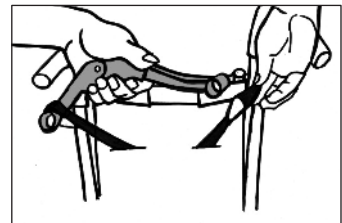

Fig. 104

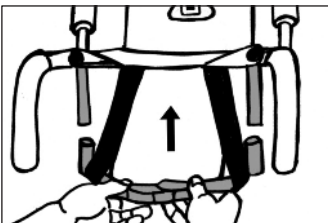

Fig. 105

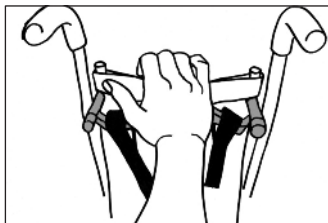

Fig. 106

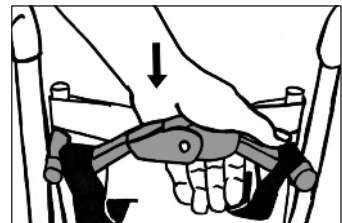

Fig. 107

Adjusting The Pelvic Belt Strap

To Tighten:

Tighten the pelvic belt straps by pulling on the loop located at the end of the strap.
Fig. 108

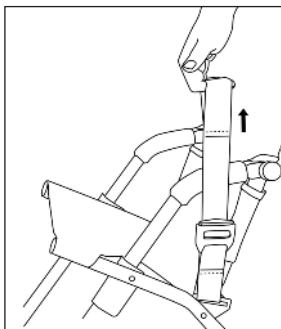

Fig. 108

To Loosen:

Loosen the pelvic belt strap by pushing the gray button on the Strap Adjustment Lock B and pulling on the end of the strap closest to the buckle. Fig. 109

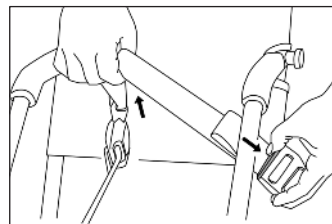

Fig. 109

Adjusting The Crotch Strap

To Tighten:

Tighten the Crotch Strap by pulling on the loop located at the end of the strap.
Fig. 110

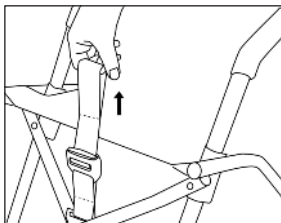

Fig. 110

To Loosen:

Loosen the Crotch Strap by pushing the gray button on the Strap Adjustment Lock and pulling. Fig. 111

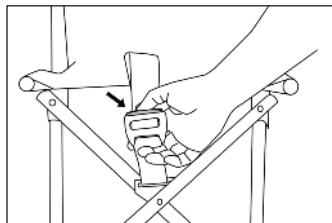

Fig. 111

Seat Cushions

Support: General Use Cushion

Flat foam with wooden insert Fig. 112

- Promotes stability and posture control and provides comfort for the user.
- Waterfall front eliminates pressure points at the back of the knees.



Fig. 112

Position: Medial Thigh Support and Anti-Thrust Cushion

Contoured foam with wooden insert Fig. 113

- Medial thigh support helps position the legs out of adduction and into better alignment, which can provide for improved weight-bearing balance and stability.
- When used with a lap belt, the 25 mm anti-thrust shelf in front of the ischials (seat bones) helps eliminate sliding or thrusting forward of the pelvis. This provides improved stability and reduces sacral sitting.



Fig. 113

Align: Lateral Pelvis and Lateral Thigh Support Cushion

Contoured foam with wooden insert Fig. 114

- Contoured edges provide lateral, pelvic and thigh positioning to reduce lateral movement of the pelvis and improve lower extremity stability.
- Increased surface contact for better weight distribution.



Fig. 114

Fitting

The fitting of the cushion should be done by a clinician. When fitted correctly, the cushion will help provide stable support and promote good posture. Consult your clinician for questions regarding individual needs.

Select the cushion size to match the seat width and depth of the chair. Measure the distance between the back of the buttocks and the back of the knees. Subtract 25mm - 51 mm to allow for adequate clearance between the seat and the back of the knees.

1. Apply wheel locks. Never leave occupied chair unattended.
2. With the material identification tag towards the rear of the chair, place the cushion onto the seat upholstery. Line up the Velcro® straps to secure the cushion in place. Front end of cushion should line up with the front edge of the seat upholstery. Position the hips of the occupant to the back of the seat. The ischials (seat bones) should be centered on the seat well of the cushion. Use positioning belt to buckle occupant into the chair.
3. Adjust the wheelchair footrest height so that the user's leg rest firmly but comfortably on the cushion. Proper footrest adjustment will enhance sitting comfort and help lower peak sitting pressures. If applicable, readjust armrest height and lateral trunk supports.

Caution

The height and weight of the occupant, in conjunction with a seat cushion, may affect the center of gravity and cause the wheelchair to become unstable, potentially resulting in injury. Prior to use, assess the stability of the wheelchair by sitting in it with the cushion attached.

Ensure the cushion's Velcro® is in good condition and is aligned properly with the Velcro on the wheelchair seat. Make sure the cushion is firmly attached. An improperly attached cushion may cause sliding, potentially resulting in injury.

Changes in the user's condition or growth, weight or changes in wheelchair equipment or accessories may require reassessment by a clinician to ensure proper cushion fit and suitability. Skin should be constantly checked by the user's caregiver for any signs of reddened areas or skin sensitivity. These areas should be brought to the attention of your clinician. The clinician should also assist you with assessing the cushion for any possible areas that have bottomed out.

Headrest Cover (Canopy)

Attaching Canopy

1. Remove Canopy from box. Fig. 115
2. Align plastic Canopy Retaining Clips with upper tubing on back of the chair. Fig. 116
3. Push on clips with the ball of your hand until they snap into place. Fig. 117



Fig. 115

! WARNING: Keep fingers away from moving parts.

4. To open, grasp top of Canopy, push forward and rotate downward. Fig. 118-120
5. To close the rear flap of Canopy, attach the Velcro® strap to Velcro® receiving patch on the edge of the Canopy Hood. Fig. 121
6. To fold, repeat above steps in reverse order. Fig. 122



Fig. 116



Fig. 117



Fig. 118



Fig. 119



Fig. 120



Fig. 121



Fig. 122

Heavy Duty Reinforced Upholstery

Heavy duty, reinforced, padded seat and seat back come with pockets which have removable plastic stiffeners. Use when extra firmness is required. Stiffeners easily lift out of pockets for custom forming with a heat gun. Fig. 123

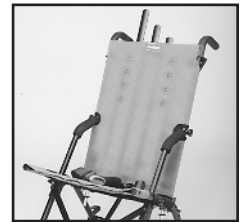

Fig. 123

Reducer Seat Insert

The Reducer Seat Insert provides proper positioning in an oversized wheelchair. This cushion easily slips into the seat of the chair to reduce the seat width 51 mm and the seat depth 25 mm. The ribbed surface provides comfort and promotes airflow. Fig. 124



Fig. 124

Rear Anti-Tip Tubes

1. To install the anti-tip tube, align the tube with the end of the square frame tubing located next to the rear wheel. Fig. 125
2. Position the anti-tip tube onto the square frame tubing (Fig. 126), and push until the “release button” pops through the hole located on the anti-tip tube. Fig. 127
3. Repeat steps 1 & 2 for opposite side.
4. To remove the anti-tip tubes, perform above steps in reverse order.



Fig. 125



Fig. 126



Fig. 127

See diagram below for how to configure anti-tip tube for your specific size.

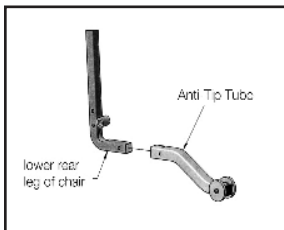

Fig. 128 (For EZ 12 & 14)

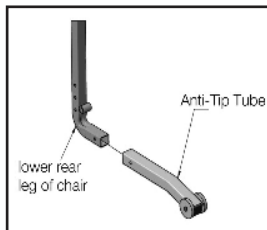

Fig. 129 (For EZ 16 & 18)

Utility Bag

The Utility Bag attaches to the back of the chair, but can be removed and converted to a tote bag. Fig. 131 & 132

To attach:

1. Hook clasps onto straps. Fig. 130

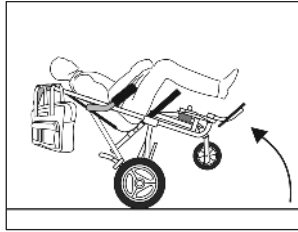

WARNING: Do not overload bag.

Fig. 130



Fig. 131



Fig. 132

Transit Models

Transit Option



Fig. 133



WARNING: Convaid belts and shoulder straps are for positioning only and are not to be used as a vehicle restraint.

5. All floor tie-down straps must be drawn tight in the front and the back to eliminate any forward/aft movement of the chair.
6. Wheelchair restraint manufacturers' instructions must be followed precisely to ensure intended performance.

Note: Tray, storage basket and other accessories must be removed during transport in bus or van, except when medically necessary.

Note: Do not overtighten. This may cause damage to the frame.

The wheelchair transport model has been crash tested and performed satisfactorily at 30 mph/20g deceleration. The optional models conform to RESNA WC-19 or ISO 7176-19 standards. Dummy weights are:

All EZ Riders

Model EZ12T.....66lbs / 30kg

Model EZ14T.....100lbs / 45.5kg

Model EZ16T.....170lbs / 77kg

Model EZ18T.....170lbs / 77kg

To reduce possibility of injury, the headrest extension must always be used with the chair. The following instructions should be followed to minimize impact in case of a crash:

1. During transit, the chair must be forward facing with tray and storage basket removed.
2. Use only a tested, proven and compatible 4-point wheelchair tie-down system (WTORS), and a 2 or 3-point occupant restraint system in accordance with WC4-18 or ISO 10542-1.
3. The wheelchair tie-downs must be securely attached to the four red anchor points on the chair. See arrows in above photo for anchor points.
4. The occupant restraints must include a lap and a shoulder bet, secured directly to the EZ Rider frame and side of roof of vehicle.

Note: Do not overtighten, this may cause damage to the frame.

Wheelchair Lateral Stability and Belt Restraint Accommodation Rating

Wheelchair Model	Mass (Weight) of Wheelchair (lb./kg)	Test Rating	Lateral Stability* (in./mm)
EZ12T	25/11.4	Acceptable	0.79/20.1
EZ14T	30/13.6	Acceptable	1.18/30.0
EZ16T	30/13.6	Acceptable	1.18/30.0
EZ18T	29/13.2	Acceptable	1.57/39.8

* “Lateral stability” is the displacement of point P (the center of gravity on the loaded wheelchair) when a platform with the loaded wheelchair is tilted 45° laterally from the horizontal. Higher numbers indicate less stability.

This table refers to tests performed in accordance with WC-19 to establish lateral stability during normal travel and the ease of use and proper fit of vehicle-anchored belt restraints. The letter designation reflects the overall rating of the lap and shoulder belt position.

Transit Mode Instructions

Using the EZ Rider Chair for Transportation in Motor Vehicles

The OPTIONAL Transit Version EZ Rider can transport users in motor vehicles that are compatible with Occupant Restraint Systems (WTORS). The chair MUST be secured in a forward-facing position with a Wheelchair Tie-down and Occupant Restraint System (WTORS), which meets the requirements of WC-4 or ISO 7176.



WARNING: The wheelchair should be used as indicated in the User’s Guide instructions accompanying the wheelchair. Failure to do so increases the likelihood of serious injury in a vehicle crash.



WARNING: Do not attach tiedowns anywhere except designated tiedown locations.





WARNING: During transit, chair must be forward facing with all accessories removed.





WARNING: Do not alter or substitute any part or component of the wheelchair, wheelchair frame or wheelchair seating system.

 **WARNING:** EZ Rider was dynamically crash tested in a forward-facing configuration using an appropriately sized crash-test dummy restrained by both upper-torso (shoulder) and lower-torso (lap) belts. To reduce the possibility of head and chest injuries resulting from contact with vehicle components, you must use both upper and lower torso belts.

 **WARNING:** Both pelvic and torso restraint belts must be used while traveling aboard a motor vehicle.

 **WARNING:** When riding aboard a motor vehicle, it is preferred that the wheelchair user transfer into the vehicle's manufacturer's seat and use a federally approved, crash-tested seat.

 **WARNING:** Whenever possible, auxiliary wheelchair equipment should be removed from the wheelchair and secured in the vehicle during transit so that it does not break free and cause injury to vehicle occupants during a crash.

 **WARNING:** Do not use the chair if it has been involved in a crash. In the event that your EZ Rider is involved in a crash, please contact the Convoid Service Dealer or Convoid Customer Service Representative in order to arrange an evaluation of your EZ Rider.

 **WARNING:** Adequate clear zones are required for occupants restrained by both upper- and lower-torso belt restraints. See Figs. 134 & 135.

RECOMMENDED CLEAR ZONES IN VEHICLE

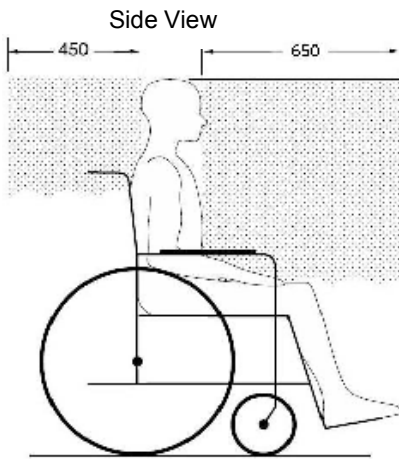

Fig. 134

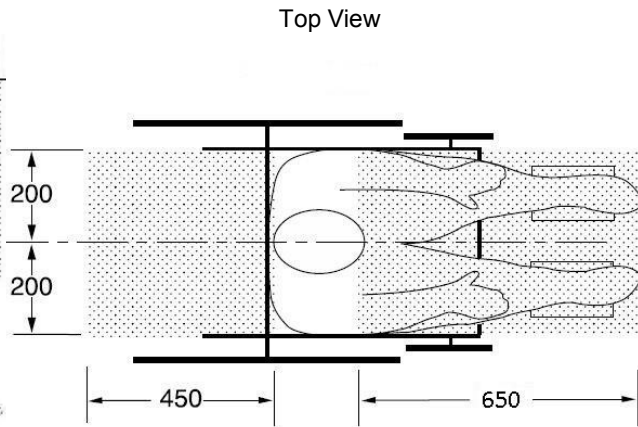

Fig. 135

The rear clear zone is measured from the rearmost point on an occupant's head. The front clear zone is measured from the frontmost point on an occupant's head.

Dimensions are shown in millimeters.

Providing Clear Space & Padding

Position the wheelchair aboard the motor vehicle to ensure sufficient clear space in front of, and behind, the occupant. See Figs. 134 & 135



WARNING: If there are any hard or sharp objects or components near the wheelchair, such as components of lifts or fold-up seats, they must be covered with heavy-duty energy-absorbing padding to ensure the safety of the wheelchair occupant and other passengers.

PROPER USE OF EQUIPMENT

Securing the Wheelchair

Attach tiedown straps to securement points (red brackets) located on the wheelchair's legs in accordance with the WTORS manufacturer's instructions. Securement points are identified by the symbol in Fig. 136 and their location on the wheelchair illustrated in Fig. 137.



Fig. 136



Fig. 137

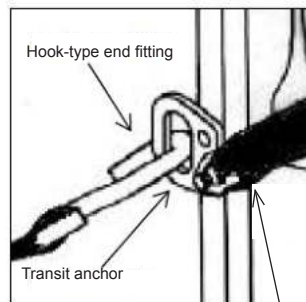

Fig. 138

Lap belt anchorage

When securing the occupied wheelchair, it is important that the WTORS anchor points on the floor and wall of the motor vehicle are positioned properly according to the WTORS manufacturer's instructions. The wheelchair must be positioned facing forward inside the vehicle. Position the wheelchair between the front and rear tiedown anchor points, allowing for the correct angle of adjustment of the tiedown straps, as illustrated in Fig. 138.

Your Convaid transit wheelchair can be easily secured by four-point strap-type tiedowns by attaching the hook end fittings of the tiedown straps to the four red securement-point brackets located on the four tubular legs of the wheelchair or by threading tiedown straps through the openings in the securement points.

The floor anchor points and wheelchair should be located:

- so that the tiedown straps follow a straight, clear path from the wheelchair securement points to the floor anchor points and
- so that the front straps are angled outward from the sides of the wheelchair and
- so that the rear straps are anchored straight back from the wheelchair securement points

Once all four tiedown straps are attached to the wheelchair:

- inspect all tiedown straps for signs of wear to the webbing and replace any straps that are worn and
- tighten the straps to remove any excess slack and provide tension between the front and rear tiedown strap securement points.

PREFERRED ANGLES OF FRONT AND REAR TIEDOWN STRAPS (Fig. 140) AND PREFERRED LOCATIONS OF FLOOR ANCHOR POINTS. Fig. 139.

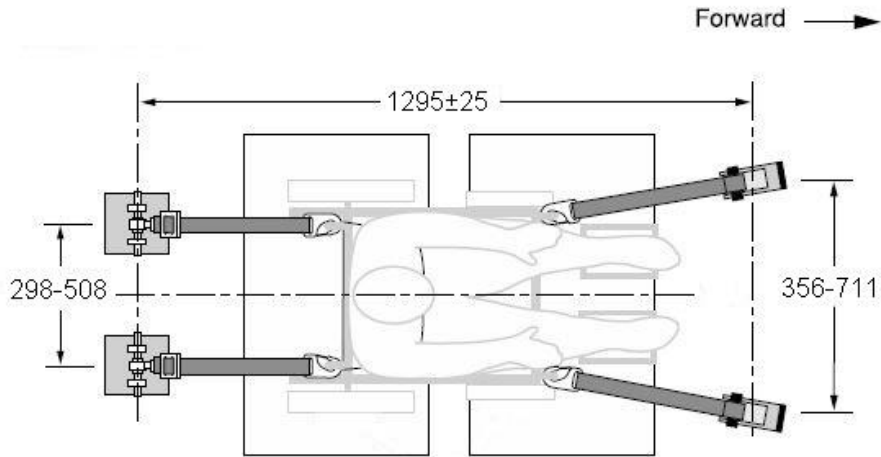

Fig. 139

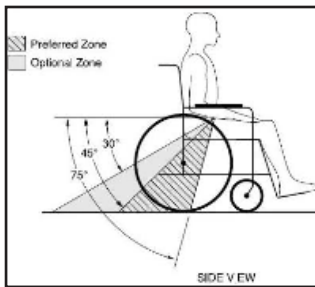

Fig. 140

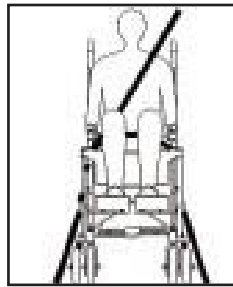

Fig. 141



Fig. 142

FIG. 141: FRONT TIEDOWN STRAPS ANGLED AWAY FROM SIDES OF WHEELCHAIR.

FIG. 142: CORRECT POSITIONS OF SHOULDER AND LAP BELT RESTRAINTS AND WHEELCHAIR TIEDOWNS.

STANDARD METAL CLIP (FIG. 143) AT LOWER END OF SHOULDER BELT AND AT END OF OPTIONAL WHEELCHAIR-ANCHORED LAP BELT USED TO CONNECT TO PIN/BUSHING (FIG. 144) ON LAP BELT OR ON WHEELCHAIR SECUREMENT POINT BRACKETS.

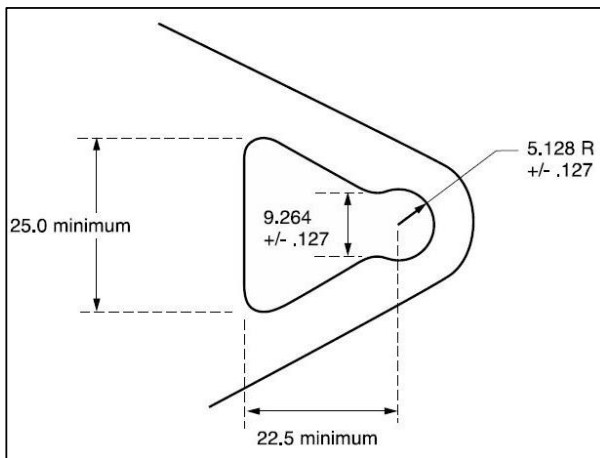

Fig. 143

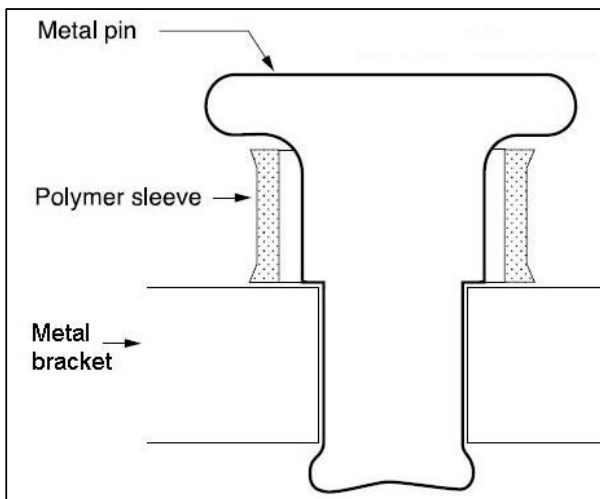

Fig. 144

Restraining the Wheelchair Occupant

Your Convaid transit wheelchair was dynamically crash tested in a forward-facing configuration using an appropriately sized crash-test dummy restrained by both upper-torso (shoulder) and lower-torso (lap) belts. To reduce the possibility of head and chest injuries resulting from contact with vehicle components, you must use both upper and lower torso belts. (See Figs. 141 & 142)

Your Convaid transit wheelchair provides for the use of an optional wheelchair-anchored lap belt. The optional belt, which has been dynamically tested in accordance with Annex A of WC19, may be ordered from Convaid at a nominal additional cost. To attach the lap belt to the wheelchair, secure the metal clips at the ends of the lap belt (Fig. 143) to the pin/bushing connectors located on the wheelchair's rear securement-point brackets. (Fig. 144)

Before loading the wheelchair onto the vehicle lift, fasten the lap belt over the wheelchair user's pelvis. The wheelchair user should wear the optional lap belt as low over the pelvis and as snugly as possible without compromising comfort. The vehicle-anchored shoulder belt may then be clipped to the pin/bushing connector located on the lap belt near where it attaches to the chair. When not in use, the optional lap belt may be looped underneath the seat, buckled, and tightened.

If the wheelchair is purchased without the optional lap belt or if the wheelchair user elects not to use the belt, a vehicle-anchored lap and shoulder belt must be used. As with the wheelchair-anchored lap belt, it is very important to position the vehicle-anchored lap belt low over the pelvis so that the angle of the lap belt is within the preferred zone of 45° to 75° to the horizontal or the optional zone of 30° to 45° to the horizontal, as shown in Fig. 139.

CONVAID USER'S GUIDE

Note: Steeper side view pelvic-belt angles are especially important if the pelvic belt is intended to be used for postural support in addition to occupant restraint in a frontal crash. Steeper angles will reduce the tendency for a vertical gap to develop between the user and the belt due to compliance of seat cushions and belt movement, thereby reducing the tendency for the user to slip under the belt or for the belt to ride up on the soft abdomen during normal use.

Note: Steeper belt angles also reduce the tendency for upper-torso belts to pull the pelvic belt onto the abdomen during frontal impact loading.

Be sure that the shoulder belt crosses the chest and the middle of one shoulder and that belt restraints are not held away from the body by wheelchair components or parts, such as arm rests or wheelchair legs. (See Fig. 145)

Thread the lap belt under the frame tubes located directly under the user's elbows and pull the belt snug against the pelvis. Ensure that belt webbing is not twisted as this may compromise safety. It is best for EZ Rider to be transported with the seat in a relatively upright orientation. However, if the seat must remain in a tilted position for medical reasons, the seat back should not be reclined more than 30° from the vertical. If it is necessary to recline the seat more than 30°, move the shoulder belt anchor point rearward on the vehicle wall so that the shoulder belt remains in contact with the wheelchair user's shoulder and chest.



Fig. 145

Using Postural Belts & Supports

Positioning accessories such as pelvic positioning belts, anterior trunk supports, and lateral trunk supports may be used while in transit, but are not designed to provide restraint during a crash. Postural supports and belts should therefore not be relied on for restraint in a vehicle crash and should be used only in conjunction with lap and shoulder belts that have been designed for restraint in a motor vehicle and crash tested in accordance with SAE J2249/ WC-4, ANSI/RESNA WC19 and/or ISO 10542-1.

Trays & Other Wheelchair Components

To reduce the risk of potential injury to the wheelchair user or other occupants in a motor vehicle crash, wheelchair-mounted accessories, such as trays and respiratory equipment, must be removed and secured separately during transit. Use tether straps or other strong attachment hardware to prevent items from breaking loose and causing injury during a crash. If it is absolutely necessary to keep a tray on the wheelchair during transit, energy-absorbing padding must be placed between the edge of the tray and the wheelchair user or serious injury may result during a crash.

WTORS Manufacturers

Convaid is a wheelchair manufacturer and does not offer wheelchair tiedown and occupant restraint systems (WTORS). However, products that comply with current WTORS standards can be obtained from the following companies that specialize in crash-tested WTORS:

Q'Straint, Sure-Lok, Unwin and Ortho Safe specialize in crash-tested tie-down systems and are in no way associated with Convaid.

Ortho Safe Systems
 P.O. Box 9435
 Trenton, NJ 08650 U.S.A
 (609) 587-9444

Q'Straint
 5553 Ravenswood Rd. #110
 Ft. Lauderdale, FL
 33312 U.S.A
 (954) 986-9987

Sure-Lok
 400 S. Greenwood Ave. #302
 Easton, PA 18045
 U.S.A (866) 787-3565

Unwin Safety Systems
 Unwin House
 The Horseshoe Coat Road,
 Martock, TA12, 6EY U.K.
 (44) (01935) 827740

Miscellaneous

Fabric Removal

Partially fold the chair to relieve fabric tension (see fold instructions on page 10). The lower seat panel is attached to the back panel with Velcro®. Remove the seat bottom. Press grey detent pin at the end of the seat extension, and take off upholstery. Fig. 146 & 147

To remove the top portion of the seat, remove the Velcro® straps that attach the seat upholstery to the frame, and take off upholstery. Lift fabric off seat tubes and away from upper handles. The seat reinforcing strap should remain on frame. Fig. 147 & 148



Fig. 146



Fig. 147



Fig. 148

Adjustable Tension Back

1. To adjust the Tension Back, unfasten the Velcro Straps and pull to desired firmness. Fig. 149
2. After adjustments are made, refasten Velcro straps. Repeat steps 1 and 2 on each set of straps. Fig. 150 & 151



Fig. 149



Fig. 150



Fig. 151

Important Information

Maintenance, Operating & Safety Instructions

- READ ALL INSTRUCTIONS BEFORE USING THE PRODUCT
- ALWAYS FOLLOW THESE SAFETY INSTRUCTIONS
- SAVE SAFETY INSTRUCTIONS FOR FUTURE REFERENCE

WARNING:



Fig. 152

- For increased safety, the seat belt should be used at all times.
- Do not leave user unattended.
- Do not strap user too tight.
- Straps should not interfere with breathing or circulation.
- Always apply wheel locks before letting go of the chair.
- If front edge of seat is at or forward of the point where tires touch the floor, avoid using front of seat tubes for support during entry or exit from chair to prevent tipping.
- Avoid using footplates for weight support during exit or entry of the chair.

Waste Disposal

The shipping carton should be kept for possible return to the manufacturer/service facility for repair or maintenance. Other paper packaging waste should be set aside for recycling. For disposition of replaced parts or the complete chair, the materials should be separated into: plastic, rubber, steel, aluminum, etc., and set aside for recycling.

Intended Use

The Convaid EZ Rider is an attendant-propelled device, its intended function and use is to provide mobility to persons with physical disabilities who are frequently or permanently non-ambulatory.

Suitable Environment

The chair is intended for both indoor and outdoor use. If the chair is used in the rain, the excess water should be wiped off with a soft cloth. If the chair is splashed with mud or corrosive substances like salt water or road salt, the chair should be washed clean with water, wiped dry and a hypoallergenic and biodegradable lubricant reapplied to the moving parts. The chair should never go into seawater, as it will corrode areas that cannot be washed clean. When going from outside to inside, clean any excess dirt or mud from the wheels to prevent soiling of inside environment.

Safety Instructions

- Follow folding/unfolding instructions.
- Never leave occupied chair unattended.
- Do not attempt to take occupied chair up or downstairs, escalators, steep inclines, or icy or slippery surfaces.

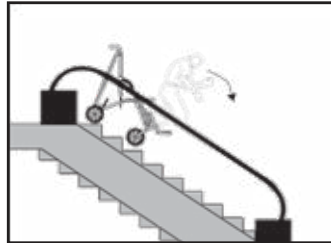
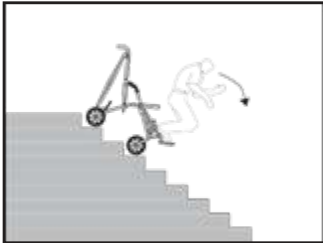

- To avoid tipping, do not overload the chair, or hang heavy items on the handles that might cause tipping.
- Be aware of newly created sharp edges.
- Frequently inspect the adjustments on the frame and the positioning accessories.
- Do not use chair after occupant has outgrown it.
- Do not ignore minor malfunctions and maintain the chair in good operating condition.
- Monitor the wheel locks (brakes) regularly and adjust as needed.
- When going up a curb or step, face the chair forward and tilt back to lift the front wheels over the curb. Move forward and lift the rear wheels over the curb.
- In case of an adverse event occurred in relation to the device incident should be reported to your local dealer and national competent authority in a timely manner. The local dealer will forward information to manufacturer.
- **If and whenever possible and feasible, the rider should transfer out of the chair and into an approved vehicle seat and passenger restraint system.**

However, if a transfer is not possible, use only designated chairs in a moving vehicle which contain the Wheelchair Tiedown and Occupant Restrain System (WTORS) following the requirements of SAE J2249. Follow tie-down harness manufacturer's instructions carefully and refer to Convaid's Transit Guide for specifics.

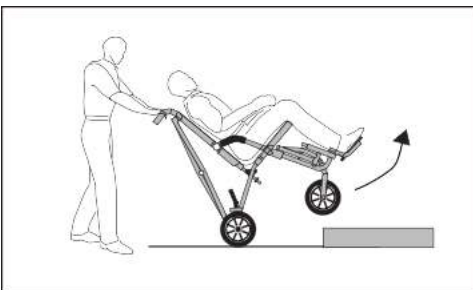

- When going up a curb or step, face forward and tilt the chair back to lift the front wheels over the curb. Move forward and lift the rear wheels over the curb.

IMPORTANT INFORMATION



- When going down a curb, approach the curb backwards. Lower the rear wheels down the curb and continue backwards, taking the weight off the front wheels so they can be gently lowered.

- When transferring user to or from chair, apply foot wheel locks.



- Maintain control of the chair at all times while going up/down ramp. Avoid steep slopes, particularly with a heavy occupant. If in doubt, do not attempt a descent unless a third party is present to help maintain control of chair.

Chair Maintenance

The following maintenance procedures should be conducted on a regular basis: Examine your Convaid product visually from time to time for possible wear and tear. Lubricant should be applied to frame and moving parts to maintain easy folding and adjustment.

a) Tire Air Pressure: The air pressure in your tires should be checked WEEKLY, since low air pressure may affect brake ability.

b) Axles and Moving Parts: Axles and moving parts should be wiped off WEEKLY with a slightly moist cloth, to remove dust, dirt and mud. Apply some lubricant after each cleaning.

c) Repair or replace loose, worn, bent, missing or damaged parts before using the chair!

d) Flat Tire: In the event of a flat tire, please contact customer service or your local dealer for specific repairing instructions.

Check for functionality and/or damage of the following:	Weekly	Every 3 months	Every 6 months	As necessary
Rims and tires	•			
Wheel lock and hand brakes	•			
Accessories	•			
Front and rear wheel axles	•			
Cleaning & lubricating all moving parts*	•			
Belts, zippers and Velcro® closures		•		
Seat/back upholstery**/tautness		•		
Armrests & foam (cushioned parts)			•	
Frame			•	
Contacting a Convoid Dealer for service or repair***				•

* Use a non-toxic, hypoallergenic lubricant for all moving parts of the frame. Do NOT use WD-40 or other silicone based spray as a lubricant.

** Follow cleaning instructions for appropriate user hygiene.

*** Repair or replacement of non-removable, worn or broken parts must be performed by a qualified service facility.

Cleaning and disinfection

To prevent the spread of germs, clean all skin contacting areas with disinfectant wipes regularly. Keep frame dry and apply a non-toxic, hypoallergenic and biodegradable lubricant to all moving parts. After longer storage periods, and before further use, the entire chair needs to be serviced, cleaned, and disinfected.

Cleaning of frame

Frame is to be kept dry and free of dirt and should be wiped off with a non-toxic, hypoallergenic and biodegradable wipe. Lubricant should be applied to moving parts as needed to maintain easy folding and adjustment.

Corrosive substance such as salt water should be avoided at all times. If exposed the frame should be wiped off with a moist towel as soon as possible. Water and a soft cloth are sufficient for basic cleaning.

Cleaning of wheels and brakes

Wheels and locks should be kept free of dirt or mud after each use. Foreign objects could cause interference with moving parts. Wipe wheels and locks with a moist cloth as needed.

IMPORTANT INFORMATION

Cleaning of fabric cover

Seat and back upholstery can be easily removed, washed, air dried and reattached to the chair. Use standard detergent to wash fabric.

Cushioned parts can also be removed from chair, washed or wiped off with a moist cloth. Before reattaching them to the chair, make sure they are completely dry. Use mild detergent to wash fabric. Use gentle cycle and cold water. Hang Dry.

Parts that are permanently attached may be wiped thoroughly with a moist cloth. Allow sufficient time to dry before placing user in chair.



Storage

Store your chair in a clean, dry area and avoid extended exposure to heat or moisture. After extended storage periods, and before reuse, the entire chair needs to be serviced, cleaned and disinfected.

Reuse

Your Convaid chair should undergo wipe-down disinfection before reuse.

Please use a non-toxic, biodegradable disinfectant solution suitable for surface disinfection. Please check the following components for intactness before operation. (see MAINTENANCE CHART)

Repair or replace if necessary:

- Wheels (tread pattern), air pressure if applicable
- Frame
- Seat and back upholstery
- Wheel lock operation
- Bearings and axles: check wear and tear/ lubrication
- Straight-running stability of wheels
- Attachments

Repairs

User: The user can replace easily removable parts or accessories, e.g. foot supports, heel loops, all fabric items, hand grips, etc.

Manufacturer/Service Facility: Repair or replacement of permanently attached, worn or broken parts must be performed by a qualified service facility. Any individual part of the chair can be replaced. Contact the manufacturer/service facility for needed repairs. The chair should be packaged in the original or suitable shipping carton for return to the manufacturer/service facility. Ship via UPS.

Tools Required

- Tools needed include 3/8", 7/16", 3/8" or 2 adjustable wrenches with 3/4" capacity, Phillips head screwdriver 5/32"
- Allen wrench (included)

Spare Parts

If you need any spare parts for your chair, please visit or call the Convoid service dealer you purchased this chair from. If the part is not under warranty, you will receive an estimate of the cost and, if necessary, shipping instructions for the return of the chair for repairs.

Functional Tests

All four wheels should make contact with the floor. With the chair empty, push it forward on a smooth level surface with enough momentum to travel six feet (2 m). The chair should not veer to the left or right more than six inches (150 mm). Wheels should be free running. Following the fold/unfold instructions; the chair should fold/unfold smoothly without undue effort. All fasteners should be secure. Fasteners on moving joints should not be overtight. Seat fabric should not be wide-stretched or sagging. Positioning accessories should be correctly adjusted and secure.

CE Mark Authorized Representative

R82 A/S

Parallevej 3,
8751 Gedved, Denmark

Convoid Service Dealer

Please record the Convoid Dealer from which you purchased your chair:

Company: _____
 Address: _____
 Phone: _____ Website: _____
 Contact: _____ Email: _____
 Serial #: _____

Or contact Convoid Customer Service at
 844 US Mobility (844-876-6245) (+1-310-618-0111) or
 sales@convoid.com

.....

Warranty

Convoid warrants to the original retail purchaser of the Convoid product, that if any part thereof proves functionally defective in material or workmanship within the specified warranty period, such defective part will be repaired or replaced (at Convoid's discretion) free of charge. Warranty service may be performed by Convoid service center or (at Convoid's discretion) the factory.

Warranty Period

Frame & X-Braces5 years
Other components.....One year
Fabric & webbingOne year
Sensiform cushionTwo years

This warranty does not cover normal wear and tear or damage caused by accident or misuse. To exercise this limited warranty, the user should first obtain a Return Authorization Number from Convoid's customer service. The product must be delivered charges pre-paid (UPS recommended) to the factory or to an authorized service center, together with a copy of the original invoice, the Return Authorization Number and a written description of the problem.

THIS LIMITED WARRANTY EXCLUDES ANY CLAIM FOR INCIDENTAL OR CONSEQUENTIAL DAMAGES. ANY IMPLIED WARRANTY APPLICABLE IS LIMITED TO THE DURATION OF THIS WRITTEN WARRANTY. SOME STATES DO NOT ALLOW THE EXCLUSION OR LIMITATIONS OF INCIDENTAL OR CONSEQUENTIAL DAMAGES OR LIMITATIONS ON HOW LONG AN IMPLIED WARRANTY LASTS, SO THE ABOVE LIMITATIONS OR EXCLUSIONS MAY NOT APPLY TO THE USER. THERE ARE NO WARRANTIES WHICH EXTEND BEYOND THE DESCRIPTION ON THE FACE THEREOF. This warranty gives the user specific legal rights and the user may have other rights that vary from state to state. Warranty applicable in USA only, may vary in other countries.

FAST FACTORY SERVICE: If being without the chair creates a hardship, the user may wish to take advantage of our Fast Factory Service, whether under warranty or not.

WARRANTY REPAIR: Simply send the chair to Convoid by UPS Next Day Air (prepaid). It will be fixed and shipped out within 48 hours by UPS Next Day Air at Convoid's expense.

NON-WARRANTY REPAIR: The time to repair and ship the chair back to the user will be extended by the length of time it takes to reach the user for approval of estimated repair costs.

The CE Mark Authorized Representative:
R82 A/S, Parallelvej 3, 8751 Gedved, Denmark



2830 California Street, Torrance, CA 90503, USA

Toll free in the US: 1-844-US-Mobility (844-876-6245) • Phone: (310) 618-0111 • Fax: (310) 618-8811

Email: sales@convoid.com • International Email: international@convoid.com

www.convoid.com

UG0012-EZ RIDER-ENG-REV_3

.....