

ENGLISH

# *User and Service Manual*



## ***Rodeo***

---

**Lightweight Tilt-In-Space Wheelchair**



READ INSTRUCTIONS BEFORE USING

SAVE THIS BOOK FOR FUTURE REFERENCE

 **Convaid**

---

# Customer Service Support

Toll Free: 1-844-US-Mobility (844-876-6245)  
Phone: (310) 618-0111  
Fax: (310) 618-8811  
Email: sales@convaid.com  
International Email: international@convaid.com  
Website: www.convaid.com

Technical assistance or repair information hours are:  
Monday-Friday, 6 a.m. to 4:30 p.m. PST

## Before Calling:

**Please fill in the following. Customer Service will be able to help you more quickly if the information indicated below is readily available.**

**Serial number of chair:** \_\_\_\_\_

**Model of chair:** \_\_\_\_\_

**Date purchased:** \_\_\_\_\_

## Notice:

The information contained in this document is subject to change without notice.

No part of this document may be photocopied, reproduced, transmitted, transcribed, stored in a retrieval system or translated to another language or computer language, in any form or by any means, electronic, mechanical, magnetic, optical, chemical, manual or otherwise without the prior written consent of Convaid.

Use only Convaid accessories and parts on Convaid products. Convaid parts are not interchangeable with other manufacturers' products. Replace any work parts immediately.

---

# Table of Contents

<b>Product Overview</b>	
Definition of Symbols.....	1
Warnings.....	3
Rodeo With Seating Overview.....	6
Rodeo Without Seating Overview.....	7
Specifications.....	8
<b>Setting Up</b>	
Contents in the Box.....	9
How To Remove Chair from Box.....	9
Preparing the Chair for Use.....	9
Tools Required.....	9
Push Handle Adjustment .....	10
Wheel Lock Operation.....	10
Unfolding the Chair.....	11
Folding the Chair.....	12
<b>Fitting Guide</b>	
Seat Back Height.....	14
Seat Width.....	14
Seat Depth.....	15
Seat Depth Adjustment Without Seating.....	15
Seat Depth Adjustment With Seating.....	16
Tilt Adjustment.....	16
Recline Function.....	17
Fabric Removal.....	18
Seat Upholstery Attachment.....	19
Pelvic Positioning Belt.....	19
Two-Point Positioning Belt.....	19
Three-Point Positioning Belt.....	20
H-Harness with Padded Covers.....	20
Footplate Adjustment.....	21
Individual Footplates.....	22
Footbox Cover.....	23
<b>Wheels</b>	
Specifications.....	24
Rear Tire Removal.....	24
Rear Tire Installation.....	25
Anti-Shimmy.....	25
<b>Accessories</b>	
Heavy Duty Under Storage Basket.....	26
Full Torso Swing-Away Support Vest.....	26
Adjustable Firm Trunk Support.....	27
Headrest Extension.....	28
Padded Headwing.....	28

.....	
Occi Headwing.....	29
Adjustable Canopy.....	30
Oxygen Tank Bag.....	30
Elevating Leg Rest.....	31
Medial Thigh Support (Abductor).....	31
Lateral Thigh Support (Adductor).....	32
Anti-Tip Tubes.....	32
Curb Tipper.....	33
Caster Locks.....	34
Utility Bag.....	34
Shoe Holders.....	34
Optional Attendant Hand Brake.....	35
Upper Extremity Support Surface (Tray).....	36
Calf Panel.....	36
Height Adjustable Flip-Up Armrests.....	37
Solid & Mesh Side Panels.....	37
Seat Cushions.....	38
Fitting.....	39
Caution.....	39
<hr/>	
<b>Transit Models</b>	
Transit Option.....	40
Transit Mode Instructions.....	41
Recommended Clear Zones in Vehicle.....	43
Providing Clear Space & Padding.....	43
Proper Use of Equipment.....	44
Restraining the Wheelchair Occupant .....	47
Using Postural Belts & Supports.....	48
Trays & Other Wheelchair Components.....	49
WTORS Manufacturers.....	49
<hr/>	
<b>Important Information</b>	
Maintenance, Operating & Safety Instructions.....	50
Warranty.....	Back Cover
<hr/>	

---

## READ BEFORE USE

Read the user's guide completely before use and fully understand its content. Familiarize yourself with the handling and functions of the product before use and practice them. Any caregiver that is going to operate this chair should also read the user's guide in full.

You are responsible for the safety of the user. The safety of the user could be affected if you do not follow the instructions in this user's guide. Nevertheless, not all possible circumstances and unpredictable situations can be covered by this user's guide. Reason, care, and circumspection are not features of the product; they are required of persons who use the product. If instructions are not clear and further explanation is necessary, please contact your Convaid provider. If you do not follow all instructions and warnings, damage to the chair or serious injury may occur. The latest version of all instructions and product safety notices are available on the Convaid website [www.convaid.com](http://www.convaid.com) and can be printed in larger sizes. Additional video instructions are also available for reference purposes.

## DEFINITION OF SYMBOLS

**WARNING!**

The word "WARNING" and/or the symbol shown above indicates practices that are unsafe or dangerous and could result in serious injury or death to the occupant of this chair or others.

**WARNING! READ USER'S GUIDE!**

Additional symbols are defined throughout this user's guide along with operating instructions.



This symbol indicates potential finger entrapment.



This symbol indicates correct lifting points for safe moving and handling.



This symbol indicates manufactured date.



This symbol indicates maximum user's weight.



This symbol indicates a wheelchair which cannot be used in motor vehicle as vehicle seat. This wheelchair does not comply with WC19 (RESNA WC-4:2012 or ISO7176-19:2008) and cannot be used as a vehicle seat to transport the user in a vehicle.



This symbol indicates a wheelchair which can be used in motor vehicle as a vehicle seat. This wheelchair complies with WC19 (RESNA WC-4:2012 and ISO7176-19:2008) and can be used as a vehicle seat to transport the user in a vehicle.



This symbol indicates the position of an anchor point when using a 4 -point tiedown system (WTORS) during transit.

## CHOOSE THE RIGHT CHAIR & SAFETY OPTIONS

There are several options available to meet the needs of the wheelchair user. Make sure that your (and your health care provider's) choice of chair and other added options takes into account the user's comfort, positioning, physical limitations, and hazards that may be encountered during daily use. Operating the manual wheelchair outside of the recommendations provided by the manufacturer can lead to a dangerous situation.

The wheelchair is not suitable for jogging, running, skating or similar activities. Swiveling front wheels tend to wobble at higher speeds and can cause a sudden stop, and the wheelchair can tip over. Use the wheelchair only at regular walking speed. Under no circumstance should you let go of the push handle while pushing.

The durability of this product is five years when it is used with proper care and maintenance according to the user's guide.

---

## General Warnings

 **WARNING:** The operator/caregiver must read and understand this user's guide prior to operating this equipment. If you are unable to understand any part of the user's guide, contact your supplier for assistance.

 **WARNING:** The weight carried by the Rodeo chair must never exceed the total weight capacity of maximum occupant size plus any items carried. When using the chair in transit, all accessories must be removed from the chair and secured separately.

 **WARNING:** To reduce the risk of an accident:

- ALWAYS carefully read the User's Guide and become comfortable with operating the chair.
- ALWAYS watch for obstacles and avoid them as often as possible.
- MAKE SURE that the chair operates properly. Repair any problems before use.
- ALWAYS verify that the quick release axles are locked so that the back wheels do not come off.
- ALWAYS secure the user into the chair during use.

 **WARNING:** Positioning belts should never be used as a safety restraint device in a motor vehicle when transporting chair with occupant. An additional WC19 compliant automotive type seat belt is required when the chair is used in transport vehicles.

 **WARNING:** Changes & Adjustments  
Adjustments made to the chair will change the balance and function of the chair and may increase risk of tip over. Consult your Convaid Service Dealer before making adjustments. Warranty will be voided if modifications that change the structure of frame of the chair are made without manufacturer's authorization.

 **WARNING:** The chair should only be used on flat, firm terrain.

 **WARNING:** Do not go up or down stairs without the assistance of another person or with user in the chair. If devices such as ramps or elevators are available, please use them. If they are not available, then the chair should be carried over the obstacle by two people without the user in the chair.

 **WARNING:** Pay particular attention when on slopes and inclines to prevent:

- The user from falling out of the chair.
- The chair from tipping over.
- The chair from rolling away.

 **WARNING:** Accessories that can be removed without any tools will not cause adverse effects on the chair.

 **WARNING:** Before removing the user from the chair and before returning the user to it, always engage the wheel lock. Never remove or place user without engaging the wheel lock.

 **WARNING:** Never leave the user unattended in the chair even when they are strapped in and the wheel locks are engaged.

 **WARNING:** Do not stand on the foot support when getting into or out of the chair.

 **WARNING:** When the user reaches for objects in front, to the side, or behind the chair, be sure that they do not lean out of the chair too far since the shift in the center of gravity might cause the chair to tilt or tip over.

 **WARNING:** Please keep packaging material away from children. Plastic packaging presents the danger of suffocation.

 **WARNING:** The chair is only intended to carry one user at a time. Do not carry more than one user at a time.

 **WARNING:** Whenever you change a setting on the chair, make sure that you firmly tighten any screws or knobs that have been loosened prior to placing the user in the chair.



 **WARNING:** Motor vehicle safety – The seating module is not designed, tested or intended to be used as a car seat. Never use the seating module as a car seat. Transfer the user from the chair to an approved motor vehicle adaptive car seat. If your chair is equipped with the transit option, refer to the transit section in this user's guide regarding use of this chair for transit.

 **WARNING:** Never use this chair on an escalator because the chair may tip over.

 **WARNING:** Many of the screws, bolts, and nuts used on this chair are specialized or high-strength fasteners. Only use fasteners purchased through Convoid or a Convoid service dealer.

 **WARNING:** Do not use the chair unless it has proper tire pressure. (Front 36 psi/Rear 30 psi, 248kPa/200kPa, 2.5BAR/2.0BAR) Do not overinflate the tires. Failure to follow these instructions may cause the tire to explode and cause harm. Tire size and maximum pressure as listed on the wheels.

 **WARNING:** The chair could lose its flame-resistant characteristics when using aftermarket seating or cushion.

 **WARNING:** Do not leave/store the chair in direct sun/heat over a long period of time. Check the temperature of the chair prior to usage.

 **WARNING:** Always properly secure the Rodeo in a safe location when transporting as cargo.

# Rodeo With Seating Overview

## Chair Warning Label

Never leave occupant unattended. Failure to read and follow user guide instructions could result in serious injury. To obtain a replacement user's guide email sales@convaid.com or call 844-876-6245.

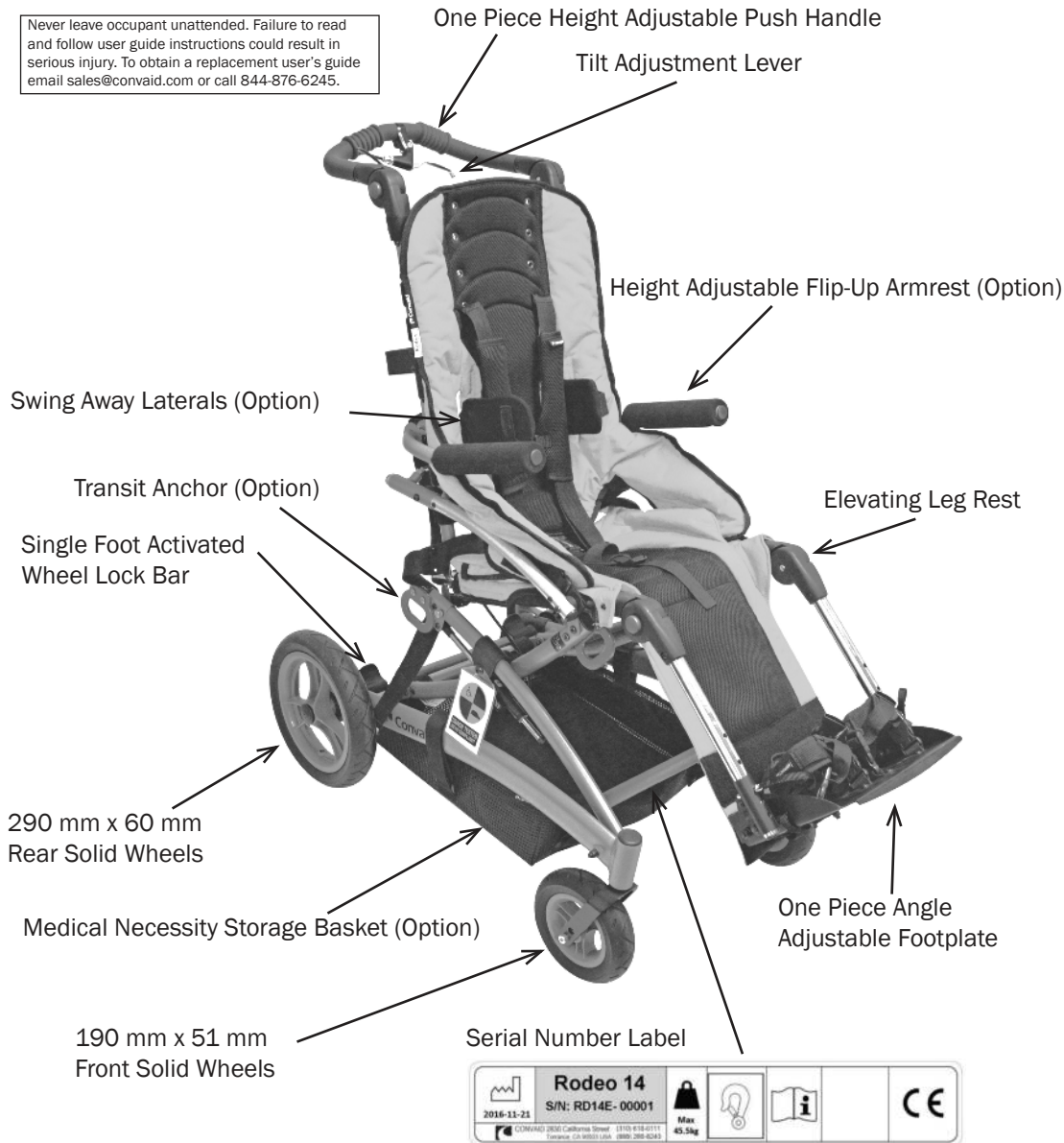

Fig. 1

# Rodeo Without Seating Overview

## Chair Warning Label

Never leave occupant unattended. Failure to read and follow user guide instructions could result in serious injury. To obtain a replacement user's guide email sales@convaid.com or call 844-876-6245.

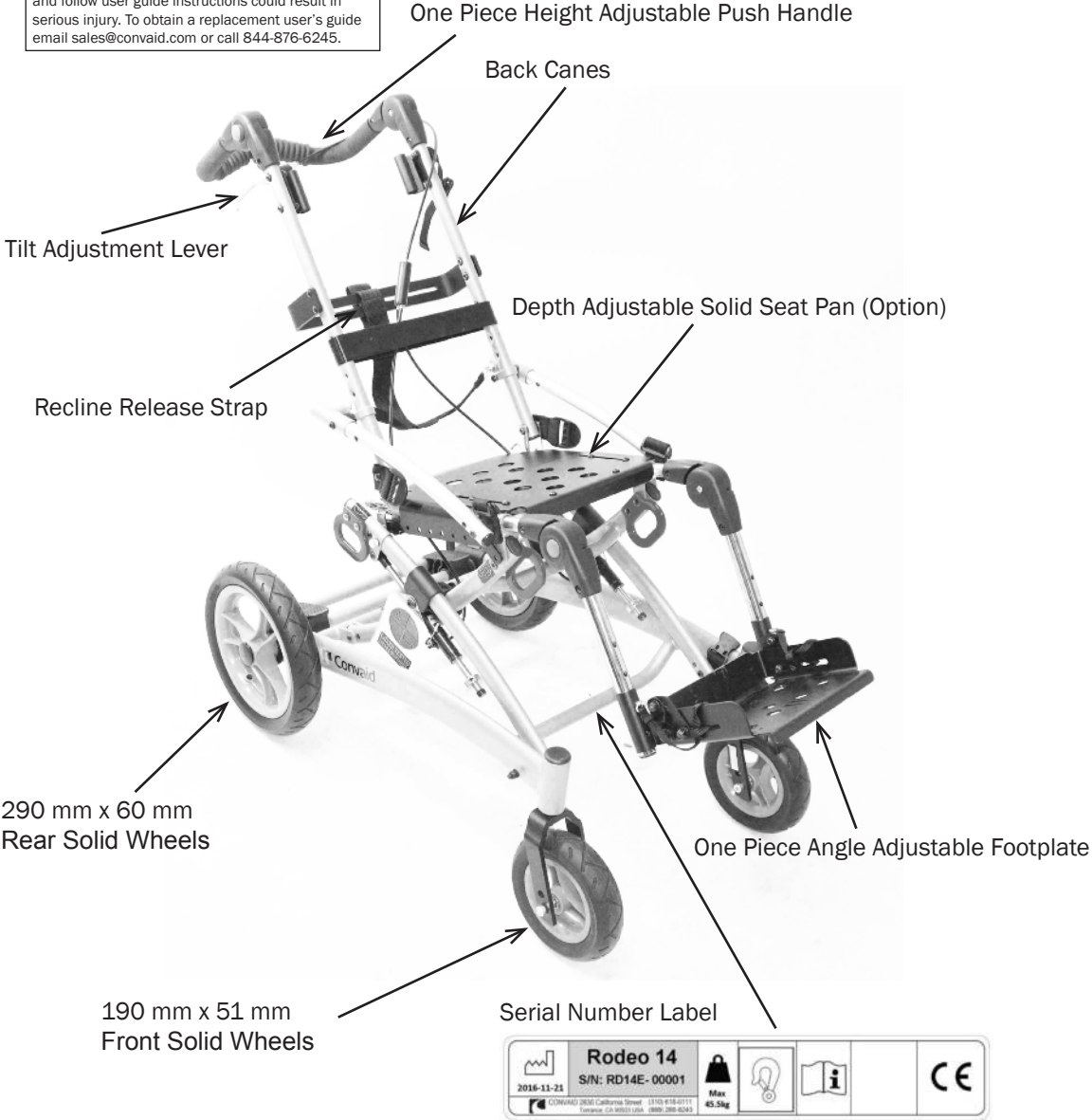

Fig. 2

# CONVAID USER'S GUIDE

## RODEO SPECIFICATIONS (Millimeters)

Model Size	RD 12	RD 14	RD 16
Seat Width	305	356	406
Seat Depth	229 - 356	279 - 406	330 - 457
Seat Depth (without seating)	229 - 356	279 - 406	330 - 457
Seat Back Height	559	610	635
Seat to Footplate	229 - 356	279 - 406	305 - 457
Seat to Floor Height	533	559	559
Recline Adjustment	90° or 110°	90° or 110°	90° or 110°
Tilt Adjustment	5 - 45°	5 - 45°	5 - 45°
Overall Height	1092	1118	1143
Overall Length	889	889	914
Overall Width	584	635	686
Maximum Slope for use of parking brakes	11°	11°	11°
Pivot Width	1346	1372	1410
Folded Length	864	864	1016
Folded Width	584	635	686
Folded Height	432	457	457
Armrest Height	121 - 178	165 - 222	165 - 222
Headrest Extension	203	203	203
Shoulder Strap Height	381 - 533	406 - 559	457 - 610
Weight Capacity Regular	34 kg	45.5 kg	77 kg
Weight Capacity Transit	30 kg	45.5 kg	75 kg
Weight of Chair	15 kg	17 kg	18 kg
Push Handle Adjustment	813 - 1232	737 - 1320	927 - 1359
Material (Mobility Base)	Steel / Aluminum		
Material (Plastic Parts)	Fiber glass strengthened polyamide		
Material (Cushion)	Fire-resistance foam*		
Material (Fabrics)	Fire-resistance nylon, polyester*		

\*Resistance to ignition of upholstered parts complies to BS-EN 1021-1 and -2

# **Chair Set Up & Adjustment**

## **Contents in the Box**

---

### **List of items included in the box:**

- Mobility base and seating module
- Set (pair) of rear wheels
- User's Guide
- Accessories as ordered
- 5/32" Allen wrench

## **How to Remove Chair from Box**

---

1. Place box flat on the floor.
2. Verify that package is in good shape and that no damage has occurred during shipping.
3. Remove the chair from the packaging material.
4. Check to make sure that your order is complete.

## **Preparing the Chair for Use**

---

Once you have all components as ordered, the directions for use in this User's Guide will guide you through the process of preparing the chair for use.

Convaid recommends the initial fitting, adjustments, and setup take place with the help of your Convaid Representative and/or Convaid Service Dealer. However, if the instructions contained in this user's guide are followed carefully, a caregiver or attendant will be able to set up and assemble the chair.

## **Tools Required**

---

- 5/32" Allen wrench
- 7/16" Wrench
- 3/8" Wrench
- Phillips Screwdriver

# Setting Up

## Push Handle Adjustment

---

1. Press both gray buttons on the outside of the pivot joints of the push handle simultaneously. Fig. 3
2. While holding the buttons down, move the push handle up or down to the desired position. Fig. 4
3. Release the gray buttons on the push handle.

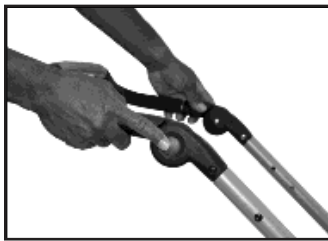

Fig. 3



Fig. 4

## Wheel Lock Operation

---

**⚠ WARNING:** Improper use may cause premature brake failure, which could damage wheel lock. Never use excessive force. This could damage the quick release plunger pins and the wheels could fall off and cause injury.

1. Lock the wheels by pushing the wheel lock bar downward. Fig. 5
2. Disengage the wheel lock by pulling the wheel lock bar upwards with the top of your foot. Fig. 6



Fig. 5 Locking



Fig. 6 Unlocking

## Unfolding the Chair

1. Lay chair down with seat facing upward. Fig. 7
2. Unbuckle closure strap. Fig. 8
3. Push in gray buttons on leg rest extensions and swing them out and upward until parallel with the ground. Fig. 9 & 10
4. Open folded footplate and attach calf support to footplate with Velcro®. Fig. 11

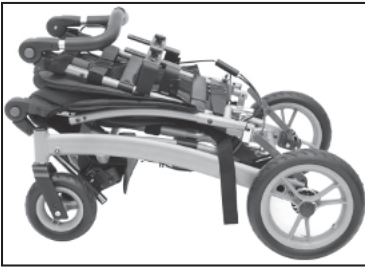

Fig. 7

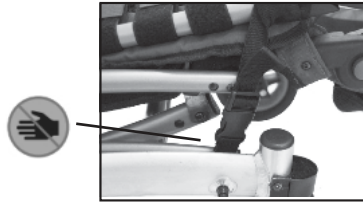

Fig. 8



Fig. 9

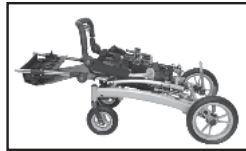

Fig. 10

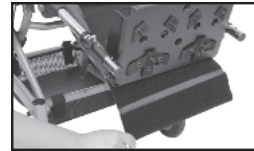

Fig. 11

5. Apply wheel lock. Fig. 12
6. Push in gray buttons on push handle, and lift upward until handle is at a 90-degree angle with the chair. Fig. 13
7. Place foot on the caster tube and push against back tubes using both hands. Make sure the safety lock clicks into place by visual inspection on both sides. Fig. 14 & 15



**WARNING:** Make sure the safety lock clicks into place. Two clicks will be heard.

Fig. 14



Fig. 12



Fig. 13

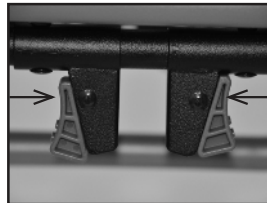

Fig. 14

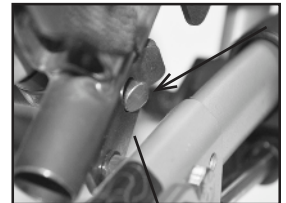

Fig. 15



**WARNING:** Look to see that safety lock pins are visible and fully exposed on both sides. (Fig. 15)



## CONVAID USER'S GUIDE

---

- Adjust push handle and footplate into desired position.
- If applicable, lower armrests, unfold lateral trunk supports and place seat cushion onto seat upholstery. Fig. 16, 17 & 18



Fig. 16

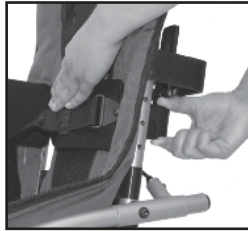

Fig. 17



Fig. 18



Fig. 19

### How to lift chair when unfolded:

With one hand, hold leg rest tube; with the other, hold the back crossbar. Fig. 19

## Folding the Chair

- Before folding, front wheels of chair should be in a forward facing position. Fig. 20
- Apply wheel lock by pushing wheel lock bar downwards. Fig. 21
- Position chair in a full upright position (not tilted or reclined). Fig. 22



Fig. 20



**WARNING:** Keep fingers free of folding mechanism.



Fig. 21



Fig. 22



Fig. 23

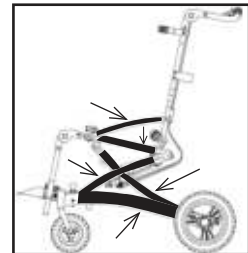

Fig. 24

**Note:** Shaded areas indicate moving parts

If applicable, flip up armrest, fold lateral trunk supports and remove seat cushion. Fig. 23, 24, 25, 26 & 27



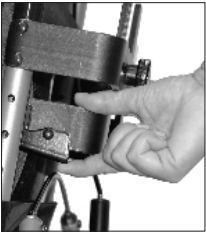

Fig. 25



Fig. 26



Fig. 27

4. Push in gray buttons on leg rest extensions, swing them upward until parallel with the ground. (Fig. 28) Detach the calf panel and fold up footplate. Fig. 29
5. To disengage safety lock, grasp red levers and simultaneously squeeze them together with one hand. With the other hand hold top of push handle pulling towards you. Fig. 30 & 31
6. Push chair downward into the folded position. Fig. 32
7. Push in gray buttons on the push handle, and rotate handle back on to chair. Fig. 33
8. Secure closure strap to hold the chair in the folded position. Fig. 34
9. Push in gray buttons on leg rest, and rotate leg rest under chair. Fig. 35
10. With a straight back, bend knees and lift chair as shown in photo. Fig. 36



Fig. 28



Fig. 29

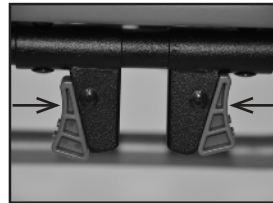

Fig. 30

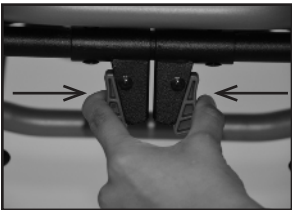

Fig. 31



Fig. 32



Fig. 33



Fig. 34



Fig. 35



Fig. 36

**!** **WARNING:** Apply lubricant to safety lock as needed.

## Fitting Guide

Correct seating and positioning encourages good posture, which in turn aids circulation, breathing and digestion.

Please take the time to properly adjust the chair to fit the user. If the user is not correctly positioned, check the accessories section of this user's guide to see if one or more of our accessories would help to facilitate posture or consult a physical therapist.

Improper seating can cause problems. Please consult a physical therapist or doctor for additional guidance.

When properly fitted, Convaid chairs will provide years of comfortable use. As the user grows, refer back to this Fitting Guide to adjust the dimensions of the chair.

### Seat Back Height

---

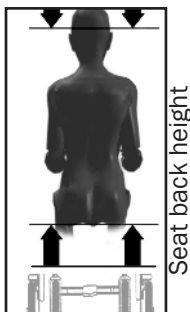

The back height varies according to chair size. Headrest extensions are available when extra height is needed to support the head.

To determine the back height, measure from the seat to the upper part of the head. Fig. 37

Fig. 37

### Seat Width

---



Proper seat width enables the user to sit comfortably and prevents problems from developing. While user is seated on a flat surface, measure from hip to hip. Fig. 38

The user should have enough room to prevent hips and thighs from rubbing against the frame. However, the chair should not be too wide or the user will slide around and posture could be affected.

Fig. 38



Fig. 39

Seat width is measured from the inside edge of the seat frame. Fig. 39

## Seat Depth

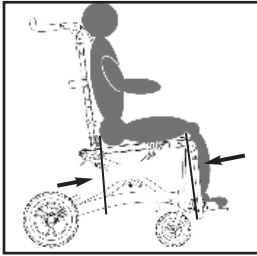

Measure from the most posterior portion of the buttocks to the back of the knee. Subtract from that measurement 25 mm - 51 mm to allow adequate clearance between the seat and the back of the knee. Fig. 40

Fig. 40

## Seat Depth Adjustment Without Seating

1. Loosen the two bolts located within the adjustment slot on the top seat pan using a 5/32" Allen wrench on top for the bolt and a 7/16" wrench for the nut on the bottom of the seat pan. Do not remove nut from bolt. Fig. 41
2. Using the same tools from step 1, remove the horizontal facing nut located under the seat pan from both the right and left side. Fig. 42
3. After the nut is removed, loosen the horizontal facing bolt on each side until the seat tubes slide freely. Do not remove the bolt entirely. Fig. 43
4. Adjust seat tubes to desired depth by aligning holes on the stationary seat base with the incremental holes on the seat tubes. Retighten the bolt from step 3 through the aligned holes to secure seat depth. Reattach nut removed in step 2.
5. Retighten the nut and bolt from step 1 to secure seat pans.

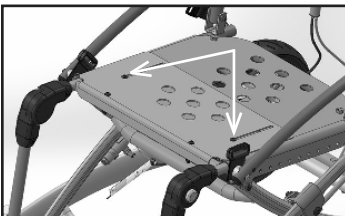

Fig. 41

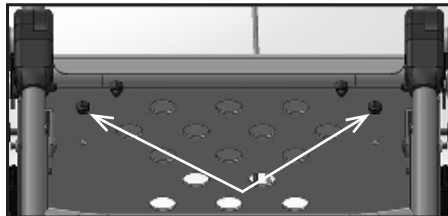

Fig. 42

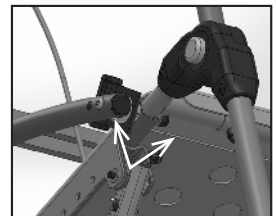

Fig. 43

## Seat Depth Adjustment With Seating

1. Push the gray buttons on the leg rest extensions; swing them upward until parallel with the ground. Fig. 44
2. Peel off seat upholstery from the mesh seat support. Fig. 45
3. Remove bolt with a 5/32" Allen wrench. Fig. 46
4. Extend the footplate tube by matching it with the holes on the seat base. Fig. 47
5. Tighten back the bolt. Fig. 48
6. Repeat on opposite side.



Fig. 44

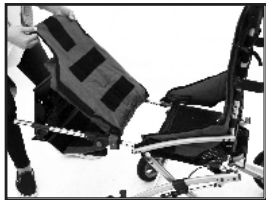

Fig. 45



Fig. 46

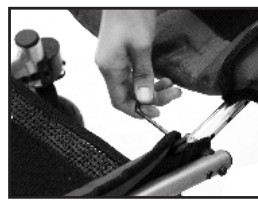

Fig. 47

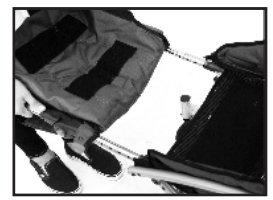

Fig. 48  
Adjust seat depth to  
desired setting

## Tilt Adjustment

The tilt feature allows for added comfort and/or convenience during feeding. To tilt, squeeze the tilt lever on the chair's handle and push down. Release the lever when desired angle of tilt has been achieved. Fig. 49 & 50



Fig. 49



Fig. 50  
5° - 45° of adjustable tilt

## Recline Function

### HELPFUL HINT:

For ease of use, lift the push handle upwards during the entire recline process.

### Upright Position

#### Step: 1

#### Rotate Push Handle downward:

Push-in the Gray Push Buttons located on the side of the push handle, at the same time, rotate the Push Handle downward.

Fig. 51 & 52



Fig. 51 Gray Push Button

#### Step: 2

#### Recline the seat back:

Lift Push Handle upward (Fig. 53) to relieve the occupant's weight. At the same time, pull upwards on the Recline Strap (Fig. 54), and recline the seat back to desired position (Fig. 55).



Fig. 52 Rotate Push Button downward

### Upright Position

To return seat back to upright position repeat steps 1 & 2. Hold top of seatback and push back up to bring upright, instead of reclining.



Fig. 53 Lift Push Handle Upwards

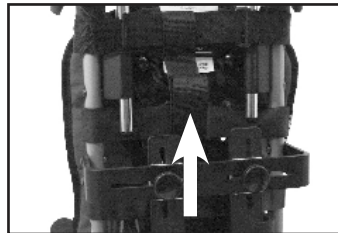

Fig. 54 Pull forward on Recline Strap

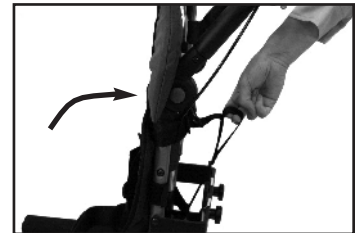

Fig. 55 Recline the seat back

## Fabric Removal

Chair upholstery may be removed to facilitate cleaning.

### Removing seat upholstery and under seat mesh support: Fig. 56-59

1. Remove screws at the front of seat tube.
2. Unfasten the Velcro® on the seat upholstery and the under seat mesh support located at the back of the seat.
3. Pull seat upholstery towards leg rest extensions.
4. Release Velcro® from calf support to remove seat upholstery from the chair.



Fig. 56



Fig. 57



Fig. 58



Fig. 59

### To adjust upholstery for individual footplates:

1. Lay Rodeo on its side for easy access to area beneath seat
2. Undo all three Velcro® straps beneath seat.
3. With upholstery extended, wrap upholstery underneath seat and refasten Velcro® straps.

### Removing back upholstery: Fig. 60-62

1. Unscrew top straps located below the push handle.
2. Release the Velcro® Straps on the back side of the chair.
3. Release Velcro® pelvic stabilizer straps and pull upholstery away.

**Note:** Do not replace upholstery until it is completely dry.



Fig. 60



Fig. 61



Fig. 62

## Seat Upholstery Attachment

The seat upholstery is attached to the mesh seat support with Velcro®. The mesh support is attached to the seat frame with Velcro® and Velcro® straps. The mesh can be tightened or loosened from the side or rear to give the seat a supportive contour.

### To contour the lower back:

1. Peel off seat upholstery. Fig. 63
2. Contour or tighten the mesh support by adjusting the Velcro® flap in the rear and the three Velcro® straps underneath. Fig. 64, 65
3. Reattach seat upholstery to mesh support.

Fig. 63

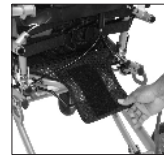
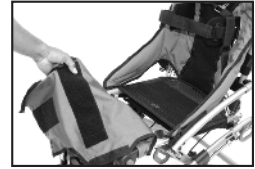

Fig. 64

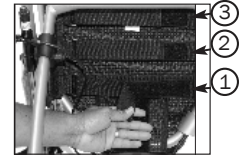

Fig. 65

## Pelvic Positioning Belts

**! WARNING:** Positioning belts should never be used as a safety restraint device in a motor vehicle when transporting chair with occupant. An additional WC-4-19 or ISO 7176-19 compliant automotive type seat belt is required when the chair is used in transport vehicles. Make sure the occupant does not slide down in the wheelchair seat.

1. The belts must be snug, but not too tight. You should be able to slide your open hand, flat between the belt and the occupant.
2. NEVER use positioning belts as a user restraint, or on an occupant who is comatose or agitated.
3. Failure to heed these warnings may cause serious injury.

## Two-Point Positioning Belt

To Buckle:

Snap together the two straps at the buckle. Fig. 66

To Release:

Press on each side to release buckle and pull away from each other.



Fig. 66



Fig. 67

To adjust seat belt, rotate plastic adjuster up to release lock. Fig. 67



Fig. 68

Rotate plastic adjuster to Release Lock. Fig. 68

## Three-Point Positioning Belt

---

To Buckle:

Slip the metal clasp on the belt strap into the crotch strap buckle.

Fig. 69

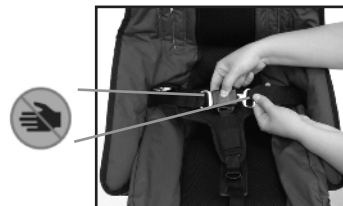

Fig. 69

To Release:

Press the gray button on the buckle and pull out the clasp.

### Depth Adjustable Strap:

The depth adjustable strap prevents the user from sliding out of the chair. It is connected with the gray quick-release buckle. It can be adjusted by threading the strap through desired slot on the seat upholstery. Fig. 70



Fig. 70

### Optional Feature:

The strap is connected with the gray quick-release buckle. It can be adjusted by threading the strap through desired slot on the seat upholstery. Fig. 71



Fig. 71

## H-Harness with Padded Covers

---

H-harness shoulder straps help the user retain upright trunk position. To adjust, insert the bolts on the end of the strap through the grommet holes on the back upholstery, and secure with the threaded knob. Choose an area in the back upholstery that will keep the user secure, but not so tight that the straps rub against the face or neck. The area should be level with or higher than the top of the shoulders. Fig. 72 & 73



Fig. 72



Fig. 73



## Footplate Adjustment

All Convaid footplates are height adjustable. To determine the correct seat-to-footplate height, measure from the back of the knee to the bottom of the heel. Fig. 74

**Note:** By flipping the footplate upside-down, it allows you to accommodate shorter leg drops than the chair is otherwise able to do in standard configuration.

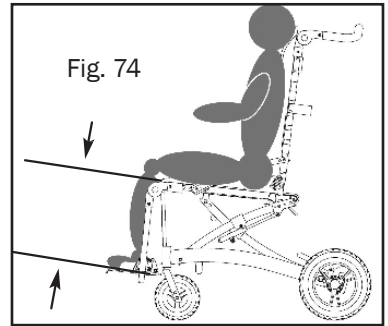

### Height Adjustment:

The soles of the feet or heels should rest comfortably on top of the footplates. To achieve this, remove detent pins on the front of the leg tubes, slide the footplate to the desired height and reinsert the pins. When the footplate is adjusted in its highest position, the excess material of the calf flap may be wrapped under the footplate and attached with Velcro®. Fig. 75 & 76

### Angle Adjustment:

To achieve comfortable foot placement, the footplate angle may be adjusted. Loosen the #1 bolt on each side, and adjust to desired position. Fig. 77



Fig. 75



Fig. 76

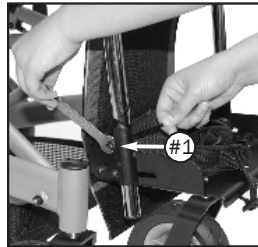

Fig. 77

### Depth Adjustment:

To adjust the depth of the footplate, loosen the #2 & #3 bolts on each side of the footplate. Slide the footplate to the desired depth, and tighten the bolts. Fig. 78

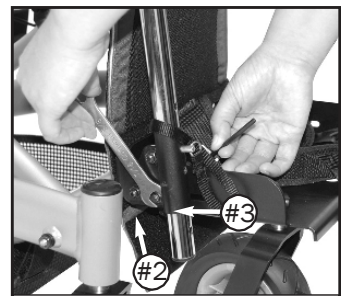

Fig. 78

## Individual Footplates

---

### To adjust minimum seat to footplate height:

1. Flip and swap the individual footplate assemblies. Fig. 79 & 80
2. Use a 5/32" Allen wrench to loosen the nuts and bolts from each footplate.
3. Slide the footplate out and adjust the lock pin to the upper locking position.
4. Reattach the footplates at desired angle.
5. Retighten hardware.
6. Adjust to desired height.

**Note:** The lock pin must be in locking position.

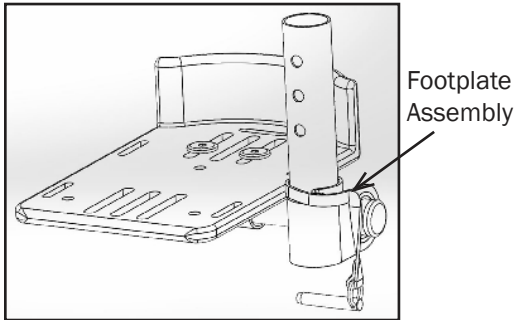

Fig. 79 Standard Footplate

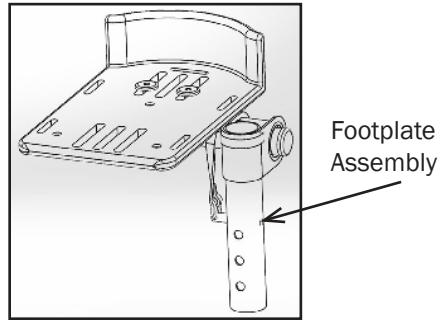
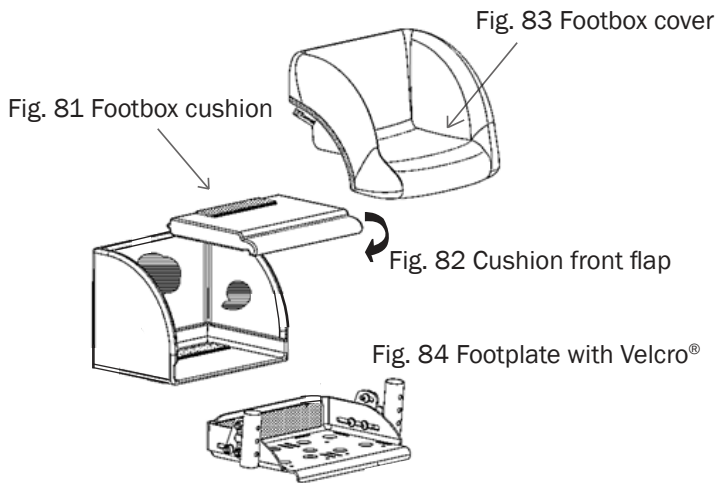

Fig. 80 Flipped Footplate

## Footbox Cover

### To install footbox cover to one-piece footplate:

1. Attach the footbox cushion to the footbox base using the Velcro®. Fig. 81  
 Note: Make sure the front flap of the box cushion is facing forward when attaching the cushion.
2. Secure the cushion to the footbox by wrapping the front flap of the cushion underneath the footbox. Fig. 82
3. After securing the cushion to the footbox, attach the cover by wrapping it over the footbox base. Fig. 83
4. Attach the footbox cover to the footplate using the provided Velcro® strip. Fig. 84



# Wheels

## Specifications

---

The Rodeo comes standard with 190 mm x 51 mm front and 290 mm x 60 mm rear solid tires. When ordering replacements or pneumatic wheels, please have the following information available:

- Chair model and size
- Wheel size

### Pneumatic Tire Sizes

---



Dimensions  
190 mm x 51 mm  
front



Dimensions  
290 mm x 60 mm  
rear

**⚠ WARNING:** Do not use the chair unless it has proper tire pressure. (Front 36 psi/Rear 30 psi, 248kPa/200kPa, 2.5BAR/2.0BAR) Do not overinflate the tires. Failure to follow these instructions may cause the tire to explode and cause harm. Tire size and maximum pressure as listed on the wheels.

## Rear Tire Removal

---

Rear Wheel Locking Pin

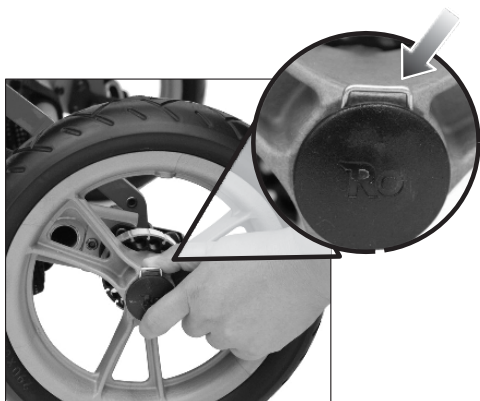

Fig. 85

Grasp wheel, press down and hold the rear wheel locking pin and pull wheel out of rear axle.

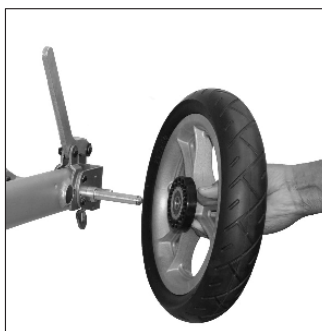

Fig. 86

**Note:** No tools are required to remove tire.

## Rear Tire Installation

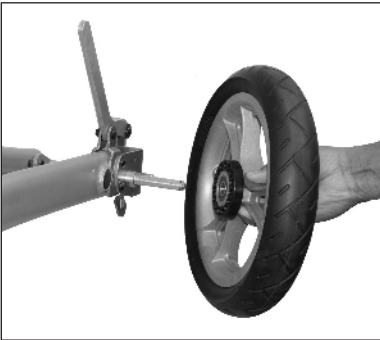

Fig. 87

To install, slide wheel onto rear axle and push with ball of hand until it clicks into place.



Fig. 88



**WARNING:** Always make sure the wheels are installed properly. You will hear a “click” when the wheel lock into place. Pull on wheel to confirm installation.

## Anti-Shimmy

In the event that the front wheels develop a shimmy, use a wrench (3/4”) to tighten the stem nut. Adjust the stem nut clockwise until the shimmy disappears. Fig. 89 & 90



Fig. 89



Fig. 90

## Accessories

Convaid offers a wide variety of supports to help properly position the user.

**Note:** Convaid's chairs provide a semi-contour fit around the body. The user must be fitted correctly into the chair to achieve optimal posture and comfort.

### Heavy Duty Under Storage Basket

---

The Heavy Duty Under Storage Basket is designed for large or heavy support equipment, such as a ventilator. It is made of texteline mesh and durable plastic and suspends from the chair frame by Velcro® straps.

 **WARNING:** Remove tray, storage basket, canopy & oxygen tank bag during transport in bus or van.



Fig. 91

### Full Torso Swing-Away Support Vest

---

The adjustable support vest keeps the user securely in place, maintains midline seating position, and prevents forward slumping.

The vest attaches with Velcro® straps around the back of the chair. To attach, insert the shoulder straps through the back upholstery grommet holes, and secure with the threaded knob. To keep the vest from sliding up, feed the side straps of the three point positioning belt through the vest loops. Adjust the side straps on the vest for proper fit around the user's trunk. Fig. 92



Fig. 92

## Adjustable Firm Trunk Supports

The lateral thoracic supports help maintain midline positioning of the trunk. To adjust the lateral thoracic supports (Fig. 93):

1. Release the double-sided Velcro® support straps on the back of the chair to allow for vertical height adjustment of the lateral trunk support. Fig. 94
2. Loosen the knobs on the lateral mounting bracket to adjust the lateral supports vertically and horizontally. Fig. 95
3. Reposition laterals to the desired location. If the thoracic supports have to be opened wider to accommodate the user's chest width, a new opening must be created in upholstery. Remove the back upholstery, and with a razor blade, slit open the second upholstery slot. Reinstall the back upholstery onto the frame. Fig. 96
4. Tighten the knobs and reposition the double-sided Velcro® support straps on the back of the chair. Fig. 97



Fig. 93



Fig. 94



Fig. 95



Fig. 96



Fig. 97

## Headrest Extension

---

Extends back height to provide head support for taller individuals. The headrest extension fits easily into sockets of the back frame. To adjust height, move rubber grommets on the mounting posts to desired position. Fig. 98 & 99



Fig. 98

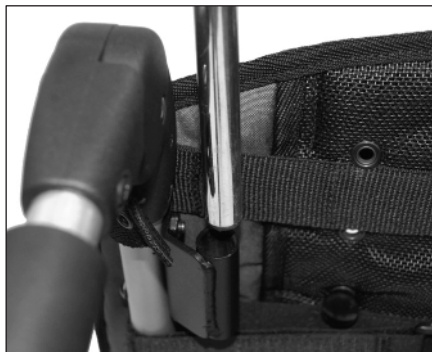

Fig. 99

## Padded Headwing

---

The padded headwing provides firm support for midline positioning. Fig. 100 The headwing can be attached at any height by wrapping the Velcro® straps around the back of the frame or headrest extension. Fig. 101



Fig. 100

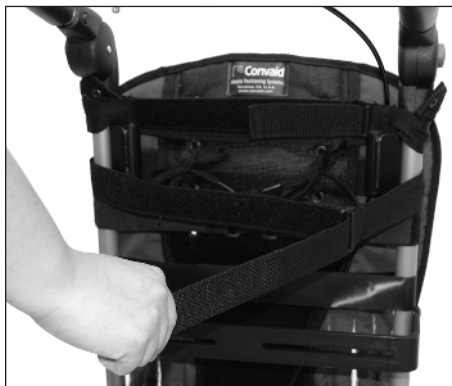

Fig. 101



**Occi Headwing**

The Occi Headwing comfortably positions the head in alignment. To attach, thread the straps through the slits in the back upholstery and attach at the back of the chair. For added securement, thread laces through the grommet holes in the upholstery, and tie. Fig. 102–107. If the Occi Headwing is mounted to the headrest extension, wrap the straps around the headrest extension and secure by lacing the threads through the grommet holes.



Fig. 102

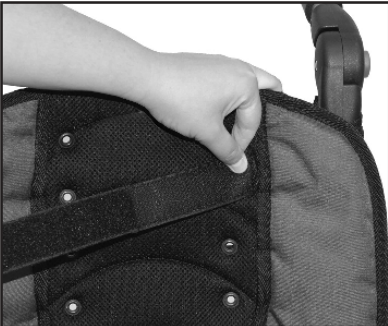

Fig. 103



Fig. 104



Fig. 105



Fig. 106



Fig. 107

## Adjustable Canopy

---

### Installation:

1. Align plastic canopy retaining clips with frame of the chair. Push on clips with the ball of your hand until they snap into place. Fig. 108 & 109
2. To open, grasp top of canopy and push forward and rotate downward. Fig. 110 & 111



Fig. 108



Fig. 109



Fig. 110



Fig. 111

## Oxygen Tank Bag

---

The oxygen tank holder holds a size 109 mm diameter tank. To attach, wrap top straps around the support bar and buckle. Wrap lower strap around frame at the base to keep bag taut when chair is tilted. Fig. 112



Fig. 112

## Elevating Leg Rest

### To Adjust Height:

1. Place your hand on the grey button located at the knee joint. Fig. 113
2. Press the grey button to adjust lower extremity to design angle and release button. Fig. 114



Fig. 113

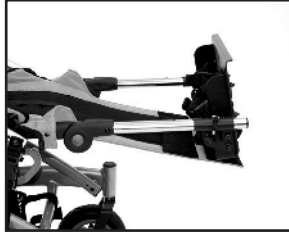

Fig. 114

## Fold or Swing-Away Lateral Supports

To fold or swing-out the lateral trunk supports, squeeze the latch located at the bottom of Lateral Support Bar, and fold the pad inwards or outwards. (Fig. 115 & 116). Make sure the lateral trunk supports are folded when you fold the chair.

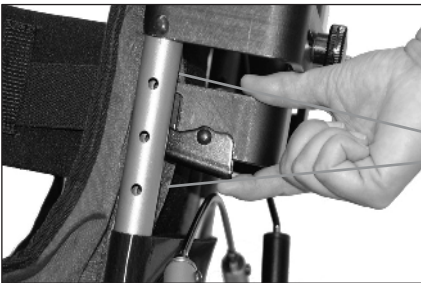

Fig. 115



Fig. 116

## Medial Thigh Support (Abductor)

Separates thighs to improve hip alignment and stabilize sitting posture. Degree of abduction can be varied and can favor one side.

1. Wrap the abductor flaps over the user's thighs from inside to outside.
2. Wrap straps under and around the side frame, attach to buckle and adjust. Fig. 117

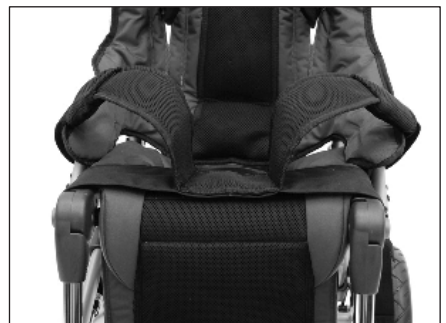

Fig. 117

## Lateral Thigh Support (Adductor)

Pulls thighs together to improve hip alignment and stabilize sitting posture. Degree of adduction can be varied.

1. Cross the adductor flaps over the user's thighs.
2. Wrap straps under and around the seat tube and attach with the buckle under seat. Fig. 118



Fig. 118

### Attendant Hand Brake - Tension Adjustment:

To adjust the brake tension, turn adjusting nut (A) counter-clockwise, then turn locknut (B) clockwise to secure nut (A) in position. Fig. 119 & 120

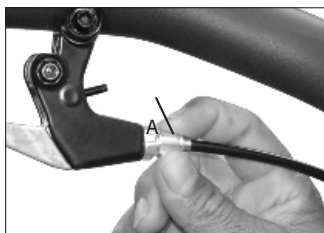

Fig. 119



Fig. 120

## Anti-Tip Tubes

1. To install the anti-tip tube, align the tube with the end of the round frame tubing located next to the rear wheel. Fig. 121
2. Push the spring button while positioning the anti-tip tube onto the round frame tubing, and then push until the "release button" pops through the hole located on the anti-tip tube. Fig. 122
3. Repeat steps 1 & 2 for opposite side. Fig. 123
4. To remove the anti-tip tubes, perform 1-3 steps in reverse order.

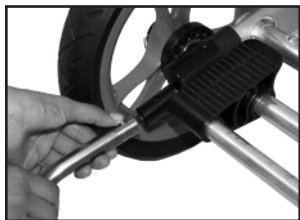

Fig. 121



Fig. 122



Fig. 123

---

## Rodeo Curb Tipper

---

1. To install the curb tipper tube, align the tube angled upwards with the end of the round mobility base tubing located next to the rear wheel. Fig. 124
2. Push the spring button while positioning the curb tipper tube into the round mobility base tubing, and then push until the “release button” pops through the hole located on the curb tipper tube. Fig. 125



Fig. 124



Fig. 125

### Indications for Use

The Convaid Rodeo models are manual wheelchairs; they are intended to provide mobility to person with disabilities who are partially or permanently non-ambulatory and limited to a sitting position.

In addition, the Rodeo transit models have been tested and comply with the requirements of RESNA WC4 Section-19:2012 and ISO 7176-19:2008, “Wheelchairs used as seating in a motor vehicle”.

### Intended Use

Convaid's Rodeo series are a lightweight ridge high-strength aluminum and steel manual wheelchair with optional removable seat pan for everyday indoor and outdoor use on flat firm terrain.

These persons typically have some form of neuromuscular disorder that limits their ability to self-propel such as Cerebral Palsy.

Note: The end user of all Convaid attendant propelled wheelchair products is not determined by age but by body dimensions and mass. Please read and follow all warnings carefully to insure the safety of the user.

## Caster Locks

1. Engage caster lock by pushing the caster lock down.  
Fig. 126
2. To disengage the caster lock, push the bottom portion of  
caster lock. Fig. 126

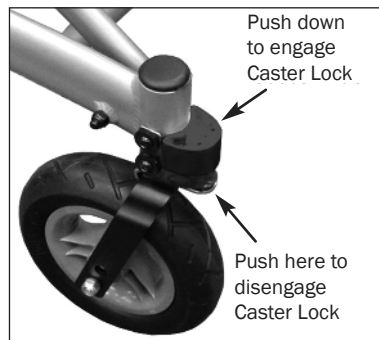

Fig. 126

## Utility Bag

The Utility Bag is for storing essential items. It attaches to the back of the chair, and can be removed and converted to a tote bag. To attach bag to chair, hook clasps into rings located on the backside of chair. Fig. 127



Fig. 127

## Shoe Holders

1. Thread the 3-bar slide onto the strap with the curved side down. Feed the strap through the  
molded strap slot. If you have the padded version, thread the pad onto the strap as shown  
Fig. 128
2. Thread the strap end through the buckle. Fig. 129
3. Thread the strap end through the 3-bar slide. Fig. 130

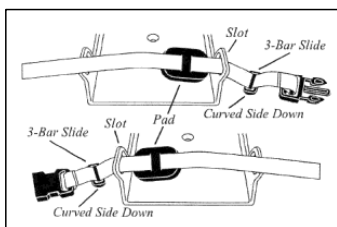

Fig. 128

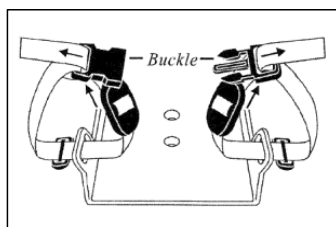

Fig. 129

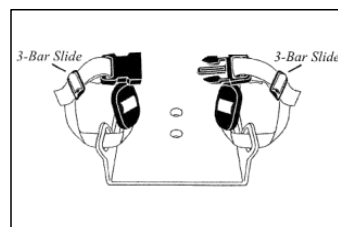

Fig. 130

## Optional Attendant Hand Brake

Hand brakes help to maintain control of the chair when going down an incline. A moderate squeeze to the lever will slow the chair; a firm squeeze will stop the chair. Fig. 131

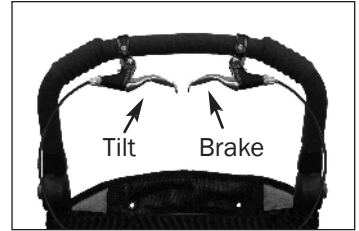

Fig. 131

### Attendant Hand Brake - Tire Installation:

Slide wheel onto rear axle, and push on wheel until it clicks into place. Fig. 132 - 134

**Important:** Before pushing on wheel, make sure the brake band is flush with the inside of the brake housing.



Fig. 132



Fig. 133



Fig. 134

**⚠ WARNING:** Always make sure the wheels are installed properly. You will hear a “click” when the wheel lock into place.

## Upper Extremity Support Surface (Tray)

---

The trays are great for feeding and for trunk stabilization. They feature a safety lip and are easy to clean.

1. Depress spring button on underside of armrest until tray mount tube pops out.
2. Grasp tray mount and extend until locked into position. Fig. 135
3. While holding the tray with both hands, squeeze black handles and slide onto ends of tray mount. Fig. 136, 137, 138 & 139
4. When returning tray mount tube inside, maintain alignment of snap in order to secure button into correct hole.



Fig. 135

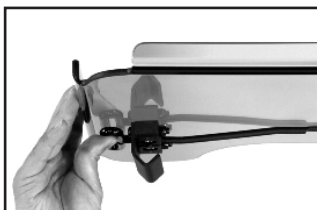

Fig. 136

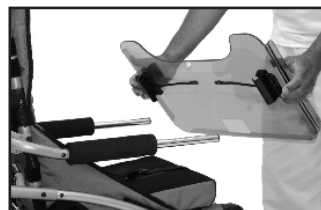

Fig. 137



Fig. 138



Fig. 139

## Calf Panel

---

The calf panel provides support for the lower legs. To attach, wrap the calf panel around leg rest extensions and Velcro® to the back of the panel. Make sure it attaches to the calf panel support (seat upholstery leg extension) Fig. 140, 141 & 142.

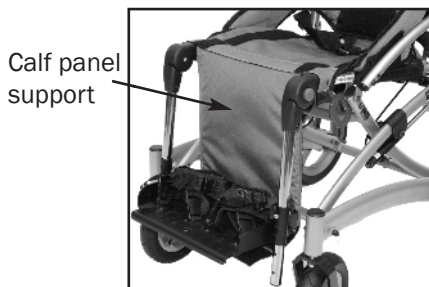

Fig. 140



Fig. 141



Fig. 142



## Height Adjustable Flip-Up Armrests

The height adjustable flip-up armrests provide added support and positioning. Armrests “flip-up” out of the way for easy access into the chair, and adjust in height for added comfort. To attach or adjust the height of the armrests, remove the two screws from each bracket, adjust bracket to the desired height, and reinsert the screws. Fig. 143 & 144



Fig. 143

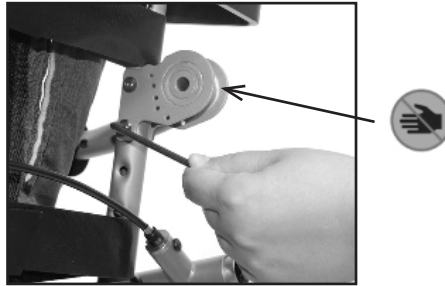

Fig. 144



**WARNING:** Do not use armrest to lift the chair.

## Solid & Mesh Side Panels

The side panels are designed to keep the occupant's arms inside the chair and to provide added security. The side panels are attached to the chair with 1 screw at the top and 2 Velcro® straps at the bottom.

The side panels will adjust to accommodate varying degrees of recline. To adjust, loosen the Velcro® strap on the front/outside of the panel, recline the chair to desired position and retighten the Velcro® strap. Fig. 145

Side panels are available in solid or mesh fabric. The mesh fabric allows for increased ventilation. Fig. 146 & 147



Fig. 145



Fig. 146



Fig. 147

## Seat Cushions

---

### **Support: General Use Cushion**

Flat foam with wooden insert. Fig. 148

- Promotes stability and posture control and provides comfort for the user.
- Waterfall front eliminates pressure points at the back of the knees.
- Cost effective cushion choice.



Fig. 148

### **Position: Medial Thigh Support and Anti-Thrust Cushion**

Contoured foam with wooden insert. Fig. 149

- Medial thigh support helps position the legs out of adduction and into better alignment, which can provide for improved weight-bearing balance and stability.
- When used with a lap belt, the 25mm anti-thrust shelf in front of the ischials (seat bones) helps eliminate sliding or thrusting forward of the pelvis. This provides improved stability and reduces sacral sitting.



Fig. 149

### **Align: Lateral Pelvis and Lateral Thigh Support Cushion**

Contoured foam with wooden insert. Fig. 150

- Contoured edges provide lateral, pelvic and thigh positioning to reduce lateral movement of the pelvis and improve lower extremity stability.
- Increased surface contact for better weight distribution.



Fig. 150

---

## Fitting

---

The fitting of the cushion should be done by an experienced clinician. When fitted correctly, the cushion will help provide stable support and promote good posture. Consult the clinician for questions regarding individual needs.

Select the cushion size to match the seat width and depth of the chair. Measure the distance between the buttocks and the back of the knees. Subtract 25 mm - 51 mm to allow for adequate clearance between the seat and the back of the knees.

1. Apply wheel lock. Never leave occupied chair unattended.
2. With the material identification tag towards the rear of the chair, place the cushion onto the seat upholstery. Line up the Velcro® straps to secure the cushion in place. Front end of cushion should line up with the front edge of the seat upholstery. Position the hips of the occupant to the back of the seat. The ischials (seat bones) should be centered on the seat well of the cushion. Use positioning belt to buckle occupant into the chair.
3. Adjust the wheelchair footrest height so that the user's legs rest firmly but comfortably on the cushion. Proper footrest adjustment will enhance sitting comfort and help lower peak sitting pressures. If applicable, readjust armrest height and lateral trunk supports.

---

## Caution

---

The height and weight of the occupant, in conjunction with a seat cushion may affect the center of gravity and cause the wheelchair to become unstable, potentially resulting in injury. Prior to use, assess the stability of the wheelchair by sitting in it with the cushion attached.

Ensure the cushion's Velcro® is in good condition and is aligned properly with the Velcro® on the wheelchair seat. Make sure the cushion is firmly attached. An improperly attached cushion may cause sliding, potentially resulting in injury.

Changes in the user's condition or growth, weight or changes in wheelchair equipment or accessories may require reassessment by a clinician to ensure proper cushion fit and suitability. Skin should be constantly checked by the user's caregiver for any signs of reddened areas or skin sensitivity. These areas should be brought to the attention of a clinician. The clinician should also assist the family with assessing the cushion for any possible areas that have bottomed out.

# Transit Models

## Transit Option



The optional wheelchair transport model has been crash tested and complies with the requirements of RESNA WC4:2012 Section 19 and ISO7176-19:2008.

	Rodeo
Model RD12T	30 kg
Model RD14T	45.5 kg
Model RD16T	75 kg

To reduce possibility of injury, the head support must always be used with the chair.

The following instructions should be followed to minimize impact in case of crash:

1. Chair must be forward facing. All non-essential accessories removed except when medically necessary.
2. Use only a tested, proven and compatible 4-point wheelchair tiedown system, and a 3-point occupant restraint system (WTORS) in accordance with WC4-18 or ISO 10542-1.
3. The wheelchair tiedowns must be securely attached to the four red anchor points on the chair. See arrows in above photo for anchor points.
4. The occupant restraints must include a lap and shoulder belt, secured directly to the Rodeo frame and side or roof of the vehicle.
5. Wheelchair restraint manufacturers' instructions must be followed precisely to ensure intended performance.

**Note:** Do not overtighten this may cause damage to the frame.

1. All floor tiedown straps must be drawn tight in the front and the back to eliminate any forward/backward movement of the chair.
2. Wheelchair restraint manufacturers' instructions must be followed precisely to ensure intended performance.

**Note:** Tray, storage basket, canopy and oxygen tank bag must be removed during transport in bus or van, except when medically necessary.

**Note:** Convaid recommends the use of all Transit Required Accessories during transportation in a motor vehicle; which include the H-harness with 3-point pelvic belt (used for positioning) and Headrest Extension. (only applicable to E1232)

**WARNING:** Convaid belts and shoulder straps are for positioning only and are not to be used as a vehicle restraint.

**Wheelchair Lateral Stability and Belt Restraint Accommodation Rating**

Wheelchair Model	Mass (Weight) of Wheelchair (lb./kg)	Test Rating	Lateral Stability (in./mm)
RD-12T	33/15	Acceptable	0.79/20.0
RD-14T	37/17	Acceptable	0.79/20.0
RD-16T	39/18	Acceptable	2.17/55.1

Lateral Stability is the displacement of point P (the center of gravity on the loaded wheelchair) when a platform with the loaded wheelchair is tilted 45° laterally from the horizontal. Higher numbers indicate less stability.

This table refers to tests performed in accordance with WC19 to establish lateral stability during normal travel and the ease of use and proper fit of vehicle-anchored belt restraints.

**Transportation Mode Instructions**

Using the Rodeo Chair for Transportation in Motor Vehicles:

The Transit Model Rodeo is for transporting users in motor vehicles when it is equipped with the OPTIONAL Transit feature and used in accordance with these instructions. The chair must be secured in a forward-facing position with Wheelchair Tiedown and Occupant Restraint Systems (WTORS), which meets the requirements of WC-4: section 18 or ISO 10542-2 Recommended Practice—Wheelchair Tiedown and Occupant Restraint Systems For Use in Motor Vehicles.

**IMPORTANT INFORMATION:**

This transit option conforms to and has been dynamically tested in accordance with RESNA WC- 4:2012 Section 19 (WC19) and ISO 7176-19:2008



**WARNING:** When riding aboard a motor vehicle, it is preferred that the wheelchair user transfer into the vehicle's manufacturer's seat and use a federally approved, crash-tested seat.



**WARNING:** Rodeo was dynamically crash tested in a forward facing configuration using an appropriately sized crash-test dummy restrained by both upper-torso (shoulder) and lower-torso (lap) belts. To reduce the possibility of head and chest injuries resulting from contact with vehicle components, you must use both upper and lower torso belts.



**WARNING:** Both pelvic and torso restraint belts must be used while traveling aboard a motor vehicle.



**WARNING:** Keep seatbelt release button away from other wheelchair components to avoid releasing during crash.



**WARNING:** Whenever possible, auxiliary wheelchair equipment should be removed from the wheelchair and secured in the vehicle during transit so that it does not break free and cause injury to vehicle occupants during a crash.



**WARNING:** Adequate clear zones are required for occupants restrained by both upper- and lower-torso belt restraints. See Figs. 151 & 152.



**WARNING:** The belt restraints must remain in position on skeletal portions of the body and not place undue stress on the abdomen.



**WARNING:** Do not alter or substitute any part or component of the wheelchair, wheelchair frame or wheelchair seating system.



**WARNING:** Do not attach tiedowns anywhere except designated tiedown locations.



**WARNING:** Do not use the chair if it has been involved in a crash. In the event that your Rodeo is involved in a crash, please contact the Convaid Service Dealer or Convaid Customer Service Representative in order to arrange an evaluation of your Rodeo.

## RECOMMENDED CLEAR ZONES IN VEHICLE

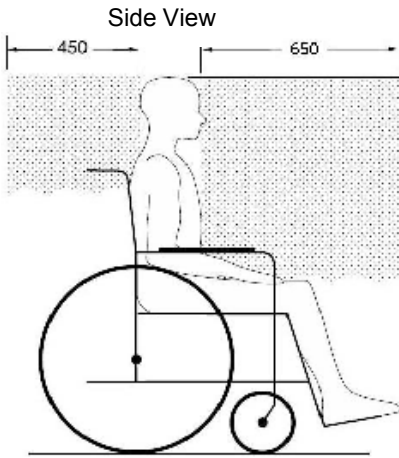

Fig. 151

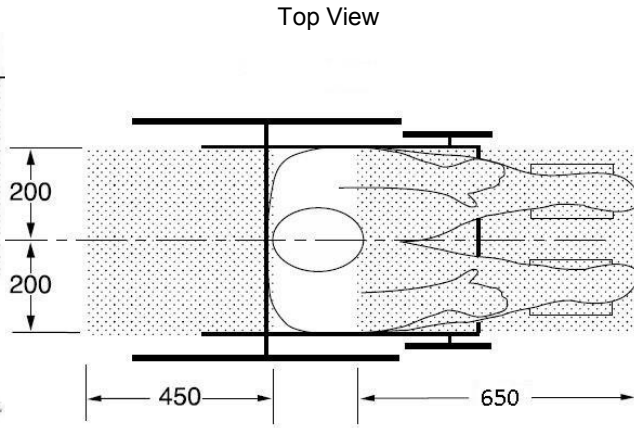

Fig. 152

The rear clear zone is measured from the rearmost point on an occupant's head. The front clear zone is measured from the frontmost point on an occupant's head.

Dimensions are shown in millimeters.

### Providing Clear Space & Padding

Position the wheelchair aboard the motor vehicle to ensure sufficient clear space in front of, and behind, the occupant. Fig. 151 & 152

**! WARNING:** If there are any hard or sharp objects or components near the wheelchair, such as components of lifts or fold-up seats, they must be covered with heavy-duty energy-absorbing padding to ensure the safety of the wheelchair occupant and other passengers.

## PROPER USE OF EQUIPMENT

### Securing the Wheelchair

Attach tiedown straps to securement points (red brackets) located on the wheelchair's legs in accordance with the WTORS manufacturer's instructions. Securement points are identified by the symbol in Fig. 153 and their location on the wheelchair illustrated in Fig. 154.



Fig. 153



Fig. 154

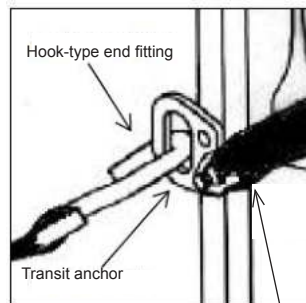

Fig. 155

Lap belt anchorage

When securing the occupied wheelchair, it is important that the WTORS anchor points on the floor and wall of the motor vehicle are positioned properly according to the WTORS manufacturer's instructions. The wheelchair must be positioned facing forward inside the vehicle. Position the wheelchair between the front and rear tiedown anchor points, allowing for the correct angle of adjustment of the tiedown straps, as illustrated in Fig. 155.

Your Convaid transit wheelchair can be easily secured by four-point strap-type tiedowns by attaching the hook end fittings of the tiedown straps to the four red securement-point brackets located on the four tubular legs of the wheelchair or by threading tiedown straps through the openings in the securement points.

The floor anchor points and wheelchair should be located:

- so that the tiedown straps follow a straight, clear path from the wheelchair securement points to the floor anchor points and
- so that the front straps are angled outward from the sides of the wheelchair and
- so that the rear straps are anchored straight back from the wheelchair securement points

Once all four tiedown straps are attached to the wheelchair:

- inspect all tiedown straps for signs of wear to the webbing and replace any straps that are worn and
- tighten the straps to remove any excess slack and provide tension between the front and rear tiedown strap securement points.



PREFERRED ANGLES OF FRONT AND REAR TIEDOWN STRAPS (Fig. 157) AND PREFERRED LOCATIONS OF FLOOR ANCHOR POINTS (Fig. 156).

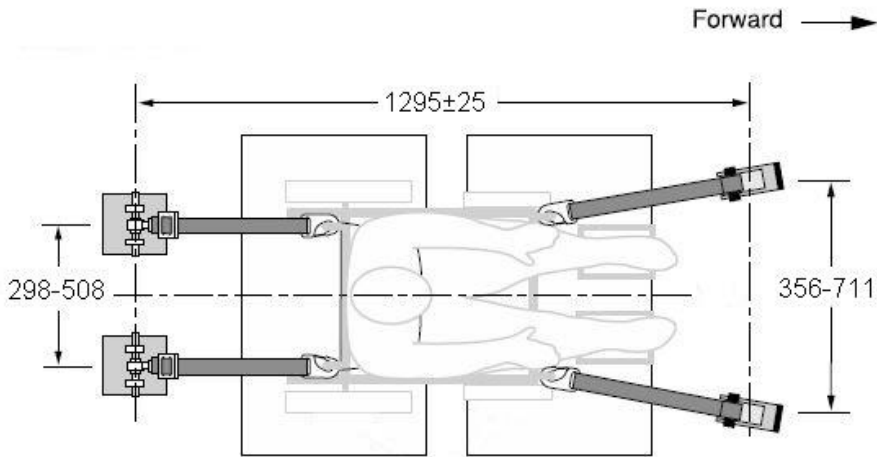

Fig. 156

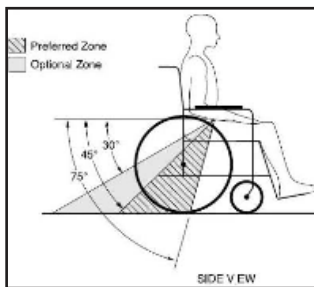

Fig. 157

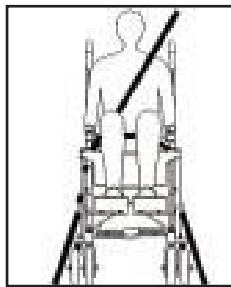

Fig. 158



Fig. 159

FIG. 158: FRONT TIEDOWN STRAPS ANGLED AWAY FROM SIDES OF WHEELCHAIR.

FIG. 159: CORRECT POSITIONS OF SHOULDER AND LAP BELT RESTRAINTS AND WHEELCHAIR TIEDOWNS.

STANDARD METAL CLIP (FIG. 160) AT LOWER END OF SHOULDER BELT AND AT END OF OPTIONAL WHEELCHAIR-ANCHORED LAP BELT USED TO CONNECT TO PIN/BUSHING (FIG. 161) ON LAP BELT OR ON WHEELCHAIR SECUREMENT POINT BRACKETS.

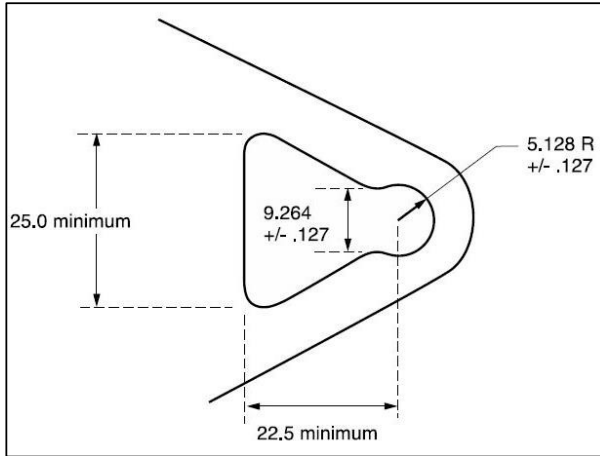

Fig. 160

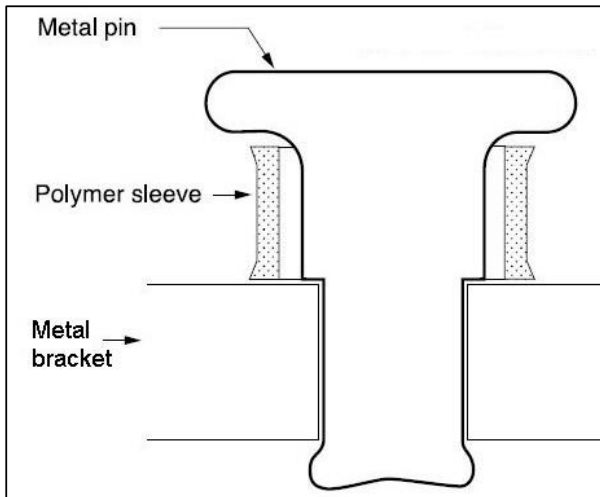

Fig. 161

---

## Restraining the Wheelchair Occupant

---

Your Convoid transit wheelchair was dynamically crash tested in a forward-facing configuration using an appropriately sized crash-test dummy restrained by both upper-torso (shoulder) and lower-torso (lap) belts. To reduce the possibility of head and chest injuries resulting from contact with vehicle components, you must use both upper and lower torso belts. (See Figs. 158 & 159)

Your Convoid transit wheelchair provides for the use of an optional wheelchair-anchored lap belt. The optional belt, which has been dynamically tested in accordance with Annex A of WC19, may be ordered from Convoid at a nominal additional cost. To attach the lap belt to the wheelchair, secure the metal clips at the ends of the lap belt (Fig. 160) to the pin/bushing connectors located on the wheelchair's rear securement-point brackets. (Fig. 161)

Before loading the wheelchair onto the vehicle lift, fasten the lap belt over the wheelchair user's pelvis. The wheelchair user should wear the optional lap belt as low over the pelvis and as snugly as possible without compromising comfort. The vehicle-anchored shoulder belt may then be clipped to the pin/bushing connector located on the lap belt near where it attaches to the chair. When not in use, the optional lap belt may be looped underneath the seat, buckled, and tightened.

If the wheelchair is purchased without the optional lap belt or if the wheelchair user elects not to use the belt, a vehicle-anchored lap and shoulder belt must be used. As with the wheelchair-anchored lap belt, it is very important to position the vehicle-anchored lap belt low over the pelvis so that the angle of the lap belt is within the preferred zone of 45° to 75° to the horizontal or the optional zone of 30° to 45° to the horizontal, as shown in Fig. 156.

## CONVAID USER'S GUIDE

---

Note: Steeper side view pelvic-belt angles are especially important if the pelvic belt is intended to be used for postural support in addition to occupant restraint in a frontal crash. Steeper angles will reduce the tendency for a vertical gap to develop between the user and the belt due to compliance of seat cushions and belt movement, thereby reducing the tendency for the user to slip under the belt for the belt to ride up on the soft abdomen during normal use.

Note: Steeper belt angles also reduce the tendency for upper-torso belts to pull the pelvic belt onto the abdomen during frontal impact loading.

Be sure that the shoulder belt crosses the chest and the middle of one shoulder and that belt restraints are not held away from the body by wheelchair components or parts, such as arm rests or wheelchair legs. (See Fig. 162)

Thread the lap belt under the frame tubes located directly under the user's elbows and pull the belt snug against the pelvis. Ensure that belt webbing is not twisted as this may compromise safety. It is best for Rodeo to be transported with the seat in a relatively upright orientation. However, if the seat must remain in a tilted position for medical reasons, the seat back should not be reclined more than 30° from the vertical. If it is necessary to recline the seat more than 30°, move the shoulder belt anchor point rearward on the vehicle wall so that the shoulder belt remains in contact with the wheelchair user's shoulder and chest.



Fig. 162

## Using Postural Belts & Supports

---

Positioning accessories such as pelvic positioning belts, anterior trunk supports, and lateral trunk supports may be used while in transit, but are not designed to provide restraint during a crash. Postural supports and belts should therefore not be relied on for restraint in a vehicle crash and should be used only in conjunction with lap and shoulder belts that have been designed for restraint in a motor vehicle and crash tested in accordance with SAE J2249/WC-4, ANSI/RESNA WC-4 :2012 and/or ISO 10542-1.

**Trays & Other Wheelchair Components**

To reduce the risk of potential injury to the wheelchair user or other occupants in a motor vehicle crash, wheelchair-mounted accessories, such as trays and respiratory equipment, must be removed and secured separately during transit. Use tether straps or other strong attachment hardware to prevent items from breaking loose and causing injury during a crash. If it is absolutely necessary to keep a tray on the wheelchair during transit, energy-absorbing padding must be placed between the edge of the tray and the wheelchair user or serious injury may result during a crash.

**WTORS Manufacturers**

Convaid is a wheelchair manufacturer and does not offer wheelchair tiedown and occupant restraint systems (WTORS). However, products that comply with current WTORS standards can be obtained from the following companies that specialize in crash-tested WTORS:

Q'Straint, Sure-Lok, Unwin and Ortho Safe specialize in crash-tested tie-down systems and are in no way associated with Convaid.

Ortho Safe Systems  
 P.O. Box 9435  
 Trenton, NJ 08650 U.S.A  
 (609) 587-9444

Q'Straint  
 5553 Ravenswood Rd. #110  
 Ft. Lauderdale, FL  
 33312 U.S.A  
 (954) 986-9987

Sure-Lok  
 400 S. Greenwood Ave. #302  
 Easton, PA 18045  
 U.S.A (866) 787-3565

Unwin Safety Systems  
 Unwin House  
 The Horseshoe Coat Road,  
 Martock, TA12, 6EY U.K.  
 (44) (01935) 827740

# Important Information

## Maintenance, Operating & Safety Instructions

---

- READ ALL INSTRUCTIONS BEFORE USING THE PRODUCT
- ALWAYS FOLLOW THESE SAFETY INSTRUCTIONS
- SAVE SAFETY INSTRUCTIONS FOR FUTURE REFERENCE

### WARNING:



- **For safety, the seat belt should be used at all times.**
- **Do not leave user unattended.**
- **Do not strap user too tight.**
- **Straps should not interfere with breathing or circulation**
- **Always apply wheel lock before letting go of the chair.**
- **Remove tray, storage basket, canopy and oxygen tank bag during transport, except when medically necessary.**
- **If front edge of seat is at or forward of the point where tires touch the floor, avoid using front of seat tubes for support during entry or exit from chair to prevent tipping.**
- **Avoid using footplates for weight support during exit or entry of the chair.**

### 1. Waste Disposal

The shipping carton should be kept for possible return to the manufacturer/service facility for repair or maintenance. Other paper packaging waste should be set aside for recycling. For disposition of replaced parts or the complete chair, the materials should be separated into: plastic, rubber, steel, aluminum, etc., and set aside for recycling.

### 2. Intended Use

This product is intended for use by a person with physical disabilities who is frequently or permanently non-ambulatory. The chair is always under the control and supervision of an attendant, and the occupant should never be left unattended. In addition the Rodeo Transit model is approved for use as seating in a motor vehicle per ANSI-RESNA WC4:2012 section 19 and ISO7176-19:2008.

### 3. Suitable Environment

The chair is intended for both indoor and outdoor use. If the chair is used in the rain, the excess water should be wiped off with a soft cloth. If the chair is splashed with mud or corrosive substances like salt water or road salt, the chair should be washed clean with water, wiped dry and a hypoallergenic and biodegradable lubricant reapplied to the moving parts. Contact with seawater should be avoided, as it will corrode areas that cannot be washed clean. When going from outside to inside, clean any excess dirt or mud from the wheels to prevent soiling of inside environment.

**4. Safety Instructions**

- Follow folding/unfolding instructions.
- Never leave occupied chair unattended.
- Do not attempt to take occupied chair up or down stairs, escalators, steep inclines, or icy or slippery surfaces.

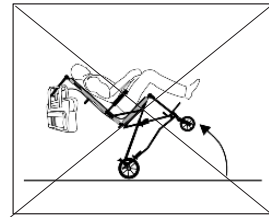
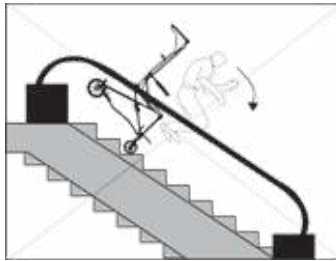
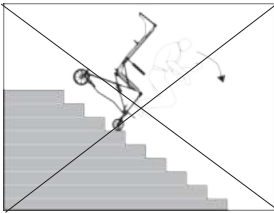

- To avoid tipping, do not overload the chair, or hang heavy items on the push handles.
- Frequently inspect the adjustments on the frame and the positioning accessories. (see maintenance chart)
- Do not use chair after occupant has outgrown it.
- Do not ignore minor malfunctions and maintain the chair in good operating condition.
- Monitor the wheel lock (brakes) regularly. (See maintenance chart)
- In case of an adverse event occurred in relation to the device, incidents should be reported to your local dealer and national competent authority in a timely manner. The local dealer will forward information to the manufacturer.

**If and whenever possible and feasible, the rider should transfer out of the chair and into an approved vehicle seat and passenger restraint system.**

However, if a transfer is not possible, use only WC19 or ISO-7176-19 compliant chairs in a moving vehicle which contain the Wheelchair Tiedown and Occupant Restraint Systems (WTORS).

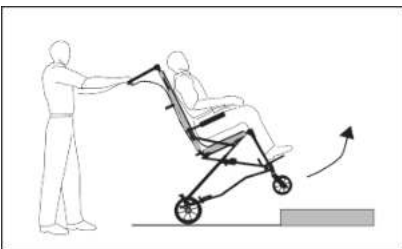

- When going up a curb or step, face forward and tilt the chair back to lift the front wheels over the curb. Move forward and lift the rear wheels over the curb.

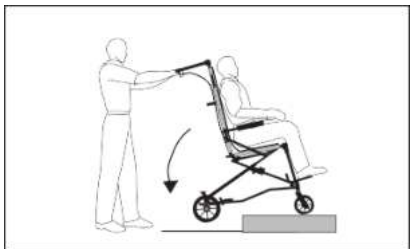

- When going down a curb, approach the curb backwards. Lower the rear wheels down the curb and continue backwards, taking the weight off the front wheels so they can be gently lowered.
- When transferring user to or from chair, apply wheel lock.



- Maintain control of chair at all times while going up/down ramp. Avoid steep slopes, particularly with a heavy occupant. If in doubt, do not attempt a descent unless a third party is present to help maintain control of chair.

### 5. User Maintenance

The following maintenance procedures should be conducted on a regular basis: Examine your Convaid product visually from time to time for possible wear and tear. Teflon™ spray\* should be applied to frame and moving parts to maintain easy folding and adjustment.

**a) Tire Air Pressure:** The air pressure in your tires should be checked WEEKLY, since low air pressure may affect brake ability.

**b) Axles and Moving Parts:** Axles and moving parts should be wiped off WEEKLY with a slightly moist cloth, to remove dust, dirt and mud. Sparingly apply a high quality Teflon™ spray\* after each cleaning. Do Not use WD-40, Silicone sprays or other lubricant sprays as they will attract dust and dirt.

**c) Repair or replace loose, worn, bent, missing or damaged parts before using the chair!**

**d) Flat Tire:** In the event of flat tire, please contact customer service or local dealer for specific repairing instructions.

\* Use a non-toxic, hypoallergenic lubricant for all moving parts of the frame.



<b>Check for functionality and/or damage of the following:</b>	Weekly	Every 3 months	Every 6 months	As necessary
Rims and tires	•			
Wheel lock and hand brakes	•			
Accessories	•			
Front and rear wheel axles	•			
Cleaning & lubricating all moving parts*	•			
Belts, zippers and Velcro® closures		•		
Seat/back upholstery**/tautness		•		
Armrests & foam (cushioned parts)			•	
Frame			•	
Contacting a Convaid Dealer for service or repair***				•

\* Use a non-toxic, hypoallergenic lubricant for all moving parts of the frame. Do NOT use WD-40 or other silicone based spray as a lubricant.

\*\* Follow cleaning instructions for appropriate user hygiene.

\*\*\***NOTE:** Repair or replacement of non-removable, worn or broken parts must be performed by a qualified service facility.

## 6. Cleaning and disinfection

To prevent the spread of germs, clean all skin contacting areas with disinfectant wipes regularly. Keep frame dry and apply a non-toxic, hypoallergenic and biodegradable lubricant to all moving parts. After longer storage periods, and before further use, the entire chair needs to be serviced, cleaned, and disinfected.

### Cleaning of frame

Frame is to be kept dry and free of dirt and should be wiped off with a non-toxic, hypoallergenic and biodegradable wipe. Lubricant should be applied to moving parts as needed to maintain easy folding and adjustment. Corrosive substance such as salt water should be avoided at all times. If exposed the frame should be wiped off with a moist towel as soon as possible. Water and a soft cloth are sufficient for basic cleaning.

### Cleaning of wheels and brakes

Wheels and brakes should be kept free of dirt or mud after each use. Foreign objects could cause interference with moving parts. Wipe wheels and brakes with a moist cloth as needed and readjust brakes if needed.

### **Cleaning of wheels and brakes:**

Wheels should be kept free of dirt or mud so as to not interfere with pushing the chair. The brakes are to be kept free of dirt or mud, so as not to interfere with locking. Wipe wheels and brakes with a moist cloth as needed and readjust brakes if indicated.

### **Cleaning of fabric cover:**

Seat and back upholstery can be easily removed, washed, air dried (a Phillips head screwdriver is required) and reattached to the chair. Use standard detergent to wash fabric. Cushioned parts can also be removed from chair, washed or wiped off with a moist cloth. Before reattaching them to the chair, make sure they are completely dry. Use standard detergent to wash fabric. Parts that are permanently attached may be wiped with a moist cloth. Allow sufficient time to dry before placing user in chair.



## **7. Storage**

Before extended storage periods, and before reuse, the entire chair needs to be serviced, cleaned and disinfected.

## **8. Reuse**

Your Convaid chair should undergo a wipe-down disinfection before reuse. Please use a non-toxic, biodegradable disinfectant solution suitable for surface disinfection. Please check the following components (see MAINTENANCE CHART) for operation, intactness, etc. and replace if necessary:

- Wheels (tread pattern), air pressure if applicable
- Frame
- Seat and back upholstery
- Wheel lock operation
- Bearings and axles: check wear and tear/lubrication
- Straight-running stability of wheels
- Attachments

## **9. Repairs**

**User:** The user can replace easily removable parts or accessories, e.g. foot supports, heel loops, all fabric items, hand grips, etc.

**Manufacturer/Service Facility:** Repair or replacement of permanently attached, worn or broken parts must be performed by a qualified service facility. Any individual part of the chair can be replaced. Contact the manufacturer/service facility for needed repairs. The chair should be packaged in the original or suitable shipping carton for return to the manufacturer/service facility. Ship via UPS.

**10. Tools Required**

**User:**

- 3/8", 7/16", 3/4" or 2 adjustable wrenches with 3/4" capacity Phillips head screwdriver
- Allen Wrench 5/32" (included)

**Service Facility/Authorized Service Dealer**

- A selection of imperial size wrenches, or two adjustable wrenches with 3/4" capacity.
- A Phillips head and a flat head screwdriver.
- A rivet setting machine with a selection of tool sizes, or a set of hand tools.
- Power drill with selection of imperial size drill bits.

**11. Spare Parts**

If the user is unable to visit a Service Facility to describe the problem, they can request a diagram of the product be sent to them, so they can draw an arrow to the part needing replacement. If not under warranty, they will receive an estimate of the cost and, if necessary, shipping instructions for return of the chair.

**12. Functional Tests**

All four wheels should make contact with the floor. With the chair empty, push it forward on a smooth level surface with enough momentum to travel 2 meters. The chair should not veer to the left or right more than 150 millimeters. Wheels should be free running and the wheel lock (brakes) adjusted to adequately secure the chair. Following the fold/unfold instructions, the chair should fold/unfold smoothly without undue effort. All fasteners should be secure. Fasteners on moving joints should not be overtight. Seat fabric should not be wide-stretched or sagging. Positioning accessories should be correctly adjusted and secure.

**CE Mark Authorized Representative**

**R82 A/S**

Parallelvej 3,  
8751 Gedved, Denmark

Convoid Service Dealer

Please record the Convoid Dealer from which you purchased your chair:

Company: \_\_\_\_\_  
 Address: \_\_\_\_\_  
 Phone: \_\_\_\_\_ Website: \_\_\_\_\_  
 Contact: \_\_\_\_\_ Email: \_\_\_\_\_  
 Serial #: \_\_\_\_\_

Or contact Convoid Customer Service at  
 844 US Mobility (844-876-6245) (+1-310-618-0111) or  
 sales@convoid.com

.....

## Warranty

Convoid warrants to the original retail purchaser of the Convoid product, that if any part thereof proves functionally defective in material or workmanship within the specified warranty period, such defective part will be repaired or replaced (at Convoid's discretion) free of charge. Warranty service may be performed by Convoid service center or (at Convoid's discretion) the factory.

### Warranty Period

Frame & X-Braces .....5 years  
Other components.....One year  
Fabric & webbing .....One year  
Sensiform cushion .....Two years

This warranty does not cover normal wear and tear or damage caused by accident or misuse. To exercise this limited warranty, the user should first obtain a Return Authorization Number from Convoid's customer service. The product must be delivered charges pre-paid (UPS recommended) to the factory or to an authorized service center, together with a copy of the original invoice, the Return Authorization Number and a written description of the problem.

THIS LIMITED WARRANTY EXCLUDES ANY CLAIM FOR INCIDENTAL OR CONSEQUENTIAL DAMAGES. ANY IMPLIED WARRANTY APPLICABLE IS LIMITED TO THE DURATION OF THIS WRITTEN WARRANTY. SOME STATES DO NOT ALLOW THE EXCLUSION OR LIMITATIONS OF INCIDENTAL OR CONSEQUENTIAL DAMAGES OR LIMITATIONS ON HOW LONG AN IMPLIED WARRANTY LASTS, SO THE ABOVE LIMITATIONS OR EXCLUSIONS MAY NOT APPLY TO THE USER. THERE ARE NO WARRANTIES WHICH EXTEND BEYOND THE DESCRIPTION ON THE FACE THEREOF. This warranty gives the user specific legal rights and the user may have other rights that vary from state to state. Warranty applicable in USA only, may vary in other countries.



2830 California Street, Torrance, CA 90503, USA  
Toll free in the US: 1-844-US-Mobility (844-876-6245) • Phone: (310) 618-0111 • Fax: (310) 618-8811  
Email: sales@convoid.com • International Email: international@convoid.com  
www.convoid.com