

frog

User Manual

CE

MD



FROG M1-X
FROG M2-X
FROG M3-X
FROG M4-X
FROG L1-X
FROG L2-X
FROG L3-X
FROG L4-X

voyar

(Intentionally left empty)

Dear Customer,

Thank you very much for the trust extended in purchasing the Voyar FROG.

Please read the user manual prior to first use of the equipment and follow its instructions.

Could you take care that the user manual remains with the product.

Technical Details are subject to changes.

(Intentionally left empty)









Contents

	Page
1. General Information	
1.1. Product Line	6
1.2. Intended Use	7
1.3. Safety Information	8
1.4. Overview of components	9
1.5. Size Adjustments	10
2. Operation	
2.1. Therapy Application	11
2.2. Unfolding the walker	12 - 13
2.3. Folding the Walker	14 - 15
2.4. Attaching Arm Supports	16 - 17
2.5. Wheel lock & Anti-reverse	18
3. Lift seat	
3.1. Seat Lifting force Adjustment	19 - 22
4. Size adjustments	
4.1. Seat Height Adjustment	23 - 25
4.2. Forearm Support Adjustment	26 - 28
4.3. Front Wheel Swivel Limit Setting	29 - 32
4.4. Frame Size Adjustment	33
4.5. Frame Width Adjustment	34
4.6. Frame Height Adjustment	35 - 36
5. Maintenance and Cleaning	
5.1. Maintenance	37
5.2. Cleaning	38
5.3. Re-use	39
6. Specifications	40
7. Identification	41

1. General Information

1.1. Product line

This user manual covers the following product variants, which are consisting of medium size and large frame versions with or without the armrest and seat features:

Frame size	With seat and armrests	With seat only	With armrests only	No seat and armrests
Medium	FROG M1-X	FROG M2-X	FROG M3-X	FROG M4-X
				
Large	FROG L1-X	FROG L2-X	FROG L3-X	FROG L4-X
				

1.2. Intended Use

The FROG gait trainer provides gait and balance support in patients with walking difficulties and can be used in the rehabilitation of gait. It has weight bearing handles and arm rests and a foldable seat as resting position. It can be used indoors in hospitals, therapy centers and ambulatory activities at home.

1.3. Safety Information

- The walker should be used indoors and on fairly firm and level ground
- Maximum weight of the user needs to be observed
- Instructions for use should be read carefully before first use. Instructions for use should be kept and remain with the product for future reference.
- All locks and adjustment knobs on the frame, armrests, seat and wheels need to be checked before first use and at regular intervals.
- The walking aid should not be used without an accompanying person. Accompanying persons must be adequately instructed.
- The users should remain within the frame during use.
- Adjustments for handle and the frame width need to remain within the marked maximum limits.

Contraindications :

Users not being able to tolerate an upright position (circulatory issues) or tolerate weight-bearing (osteogenesis imperfecta, severe osteoporosis, joint instability, severe contractures), as well as significant lack of head control.

Please report any serious incident that occurred in relation to the device to the manufacturer, XentiQ Partners Pte Ltd, and to the competent authority of the Member State where the user is established.

1.4. Overview of components



1.5. Size Adjustments

Dimensions for medium size (M) and large size (L) frames

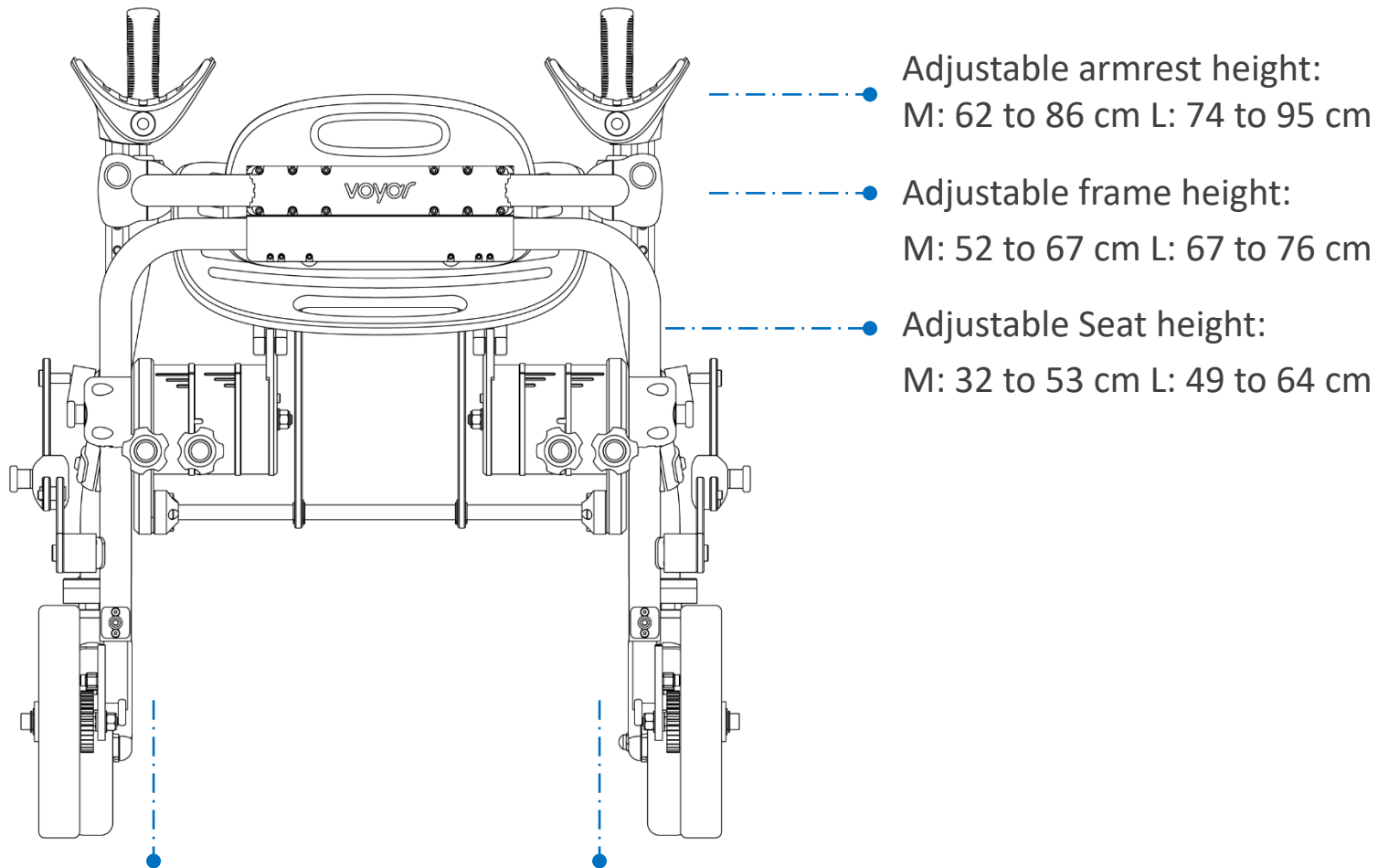

Adjustable frame width M: 38 to 46 cm L: 49 to 57 cm

2. Operation

2.1. Therapy Application

FROG is used to teach children and adolescents who need additional support and stabilization of the upper body due to disorders of the nervous and muscular system to walk and move independently.

The use of this walking aid during therapy should be supervised by a clinician. The suitability of the device depending on the degree of the condition should be assessed by a doctor or therapist and settings or adjustments made in an appropriate manner.

Particular attention should be paid to the position of the user's feet and, if necessary, the tendency to cross the feet. The use of lower leg orthoses is necessary in many cases. Getting in and out of the walker must be done with the support of the supervisor. The child should grip the handles tightly and place their forearms in the armrests. If there is insufficient control of the arms they can be stabilized with straps in the armrests.

The supervisor should accompany the user either in front of or behind the walker, paying particular attention to lateral stability (support with hands if necessary), as well as the position of the feet (avoid crossing).

The initial training takes place step by step, which can be promoted in a playful way (e.g. with a ball). Attention must be paid to fatigue, whereby regular breaks can be taken using the seat. Folding down and taking the seat as well as transferring back to standing must be practiced progressively under guidance and can then be done autonomously in most cases.

2.2. Unfolding the Walker

The rear wheel of the walker should be supported on the ground to release the plunger lock. (DO NOT lift up the walker)

1. Pull out and disengage **right** plunger lock on frame.

Note: There is no need to pull the left lock.



Unlock

1. Pull back the rear frame against front wheels on the ground.

2. Once walker is upright, ensure plunger locks on **both** sides are 'engaged' and in locked positions.

Caution: Please ensure locks are fully engaged before use.



2.3. Folding the Walker

1. Pull out and disengage plungers lock on **both** sides of the links.
2. Holding on to both sides of lock and frame, slowly articulate the rear frame forward or front frame backwards.
3. Fold walker until right lock engages to lock folded position.



4. Remove both armrests from their sockets (for models M1-X, M3-X, L1-X and L-3X with armrests; other models do not have armrest).
5. The walker is now secured and folded.



2.4. Attaching Arm Supports

(for models M1-X, M3-X, L1-X and L-3X with armrests; other models do not have armrest).

Each armrest needs to be on the correct side of the walker:

- Take note of section of arm rest that should face outwards (see below circled in red)
- Handle and knob should face forward
- Armrests can only be engaged in holder on correct side



1. Locate the armrest shaft socket.
2. Pull out lock [1] and hold it in position.
3. Holding the aluminium shaft, engage the arm support into the hole.
4. At desired position, release lock ensuring pin has engaged with hole in the shaft. If not engaged, gently slide the shaft up or down until lock snaps in.

Refer to page 28 on how to re-adjust armrest height.



2.5. Wheel lock & Anti-reverse

Each rear wheel has a anti-reverse ratchet which can be disengaged:

Anti-reverse ratchet engaged.

To release, flip tag towards the rear

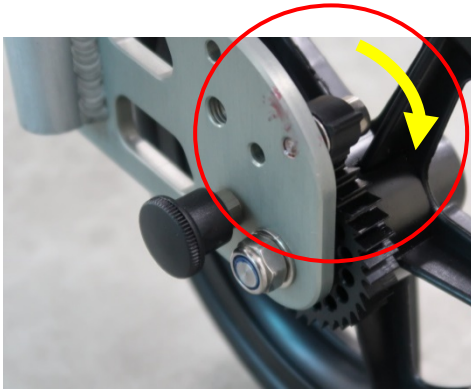

Anti-reverse ratchet released.

To engage, flip tag towards the front

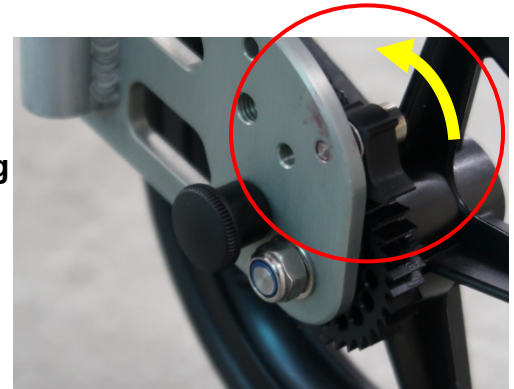

Each rear wheel can also be locked completely with a spring plunger (“parking brake”)

Wheel lock released.

To engage, rotate and release



Anti-reverse ratchet engaged.

To release, pull and turn

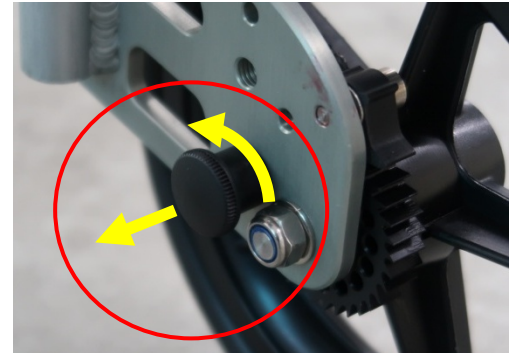

The anti-reverse ratchet and the wheel lock are maintenance free. Please verify correct functioning before initial usage.

3. Lift seat

(for models M1-X, M2-X, L1-X and L-2X with seat; other models do not have seats).

3.1. Seat Lifting Force Adjustment

Lift force of the seat is controlled by mechanisms located on both the left and right below the seat. There are two adjustable components for each side - [A] and [B].

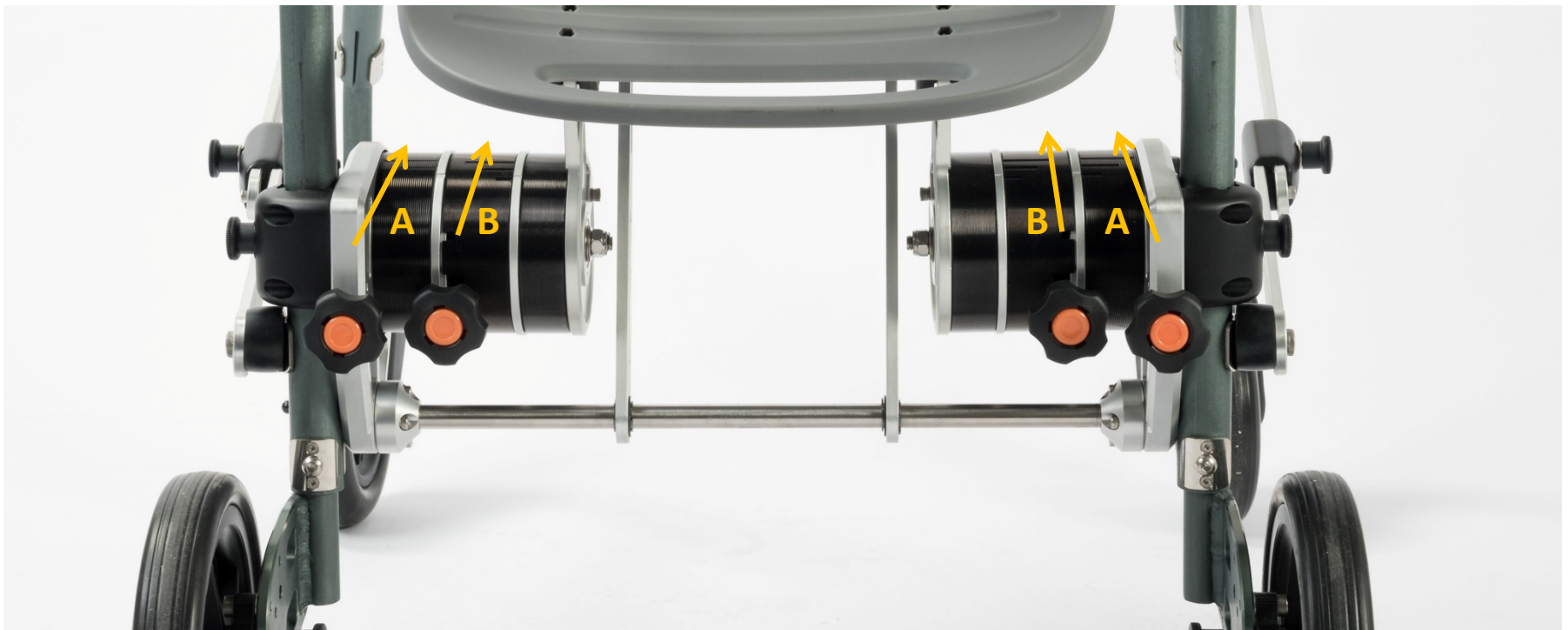

Important: Scales [A] and [B] should be adjusted equally on BOTH sides.
Adjustments should also only be done with seat in flipped up position.

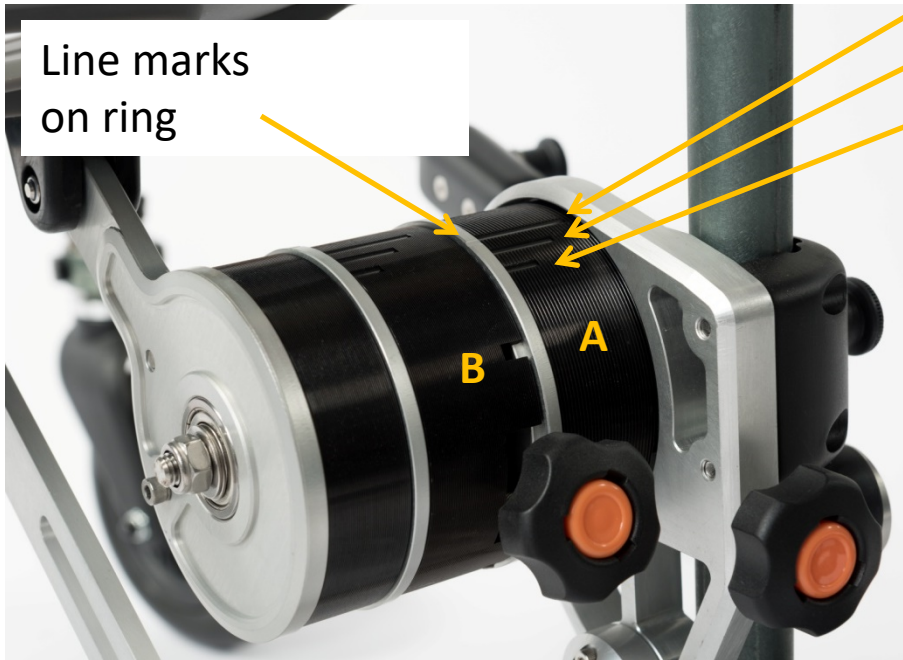

Line marks
on ring

B

A

High lifting force

Medium lifting force

Low lifting force

[A] controls the lifting **force** acting on the user when in sitting position. The higher the lifting force, the easier it is to get up.

[B] controls the transition force when the seat is in half elevated position. Decreasing [B] means it will be easier to push the seat down in transition.

Starting on one side, turn **Knob [A]** to adjust desired lift force which acts when the seat is mostly lowered down; either to low (1), medium (2) or high (3).

Repeat the same adjustments on the other side.

Spring force should be adjusted equally on BOTH drum sides before use.

Adjustments should also only be with seat in flipped up position.

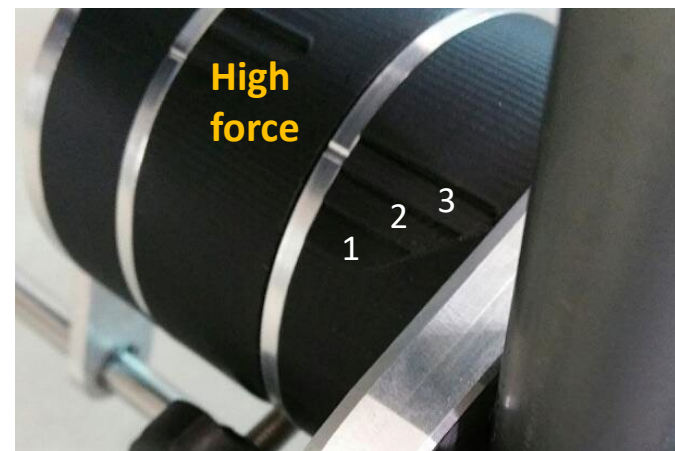
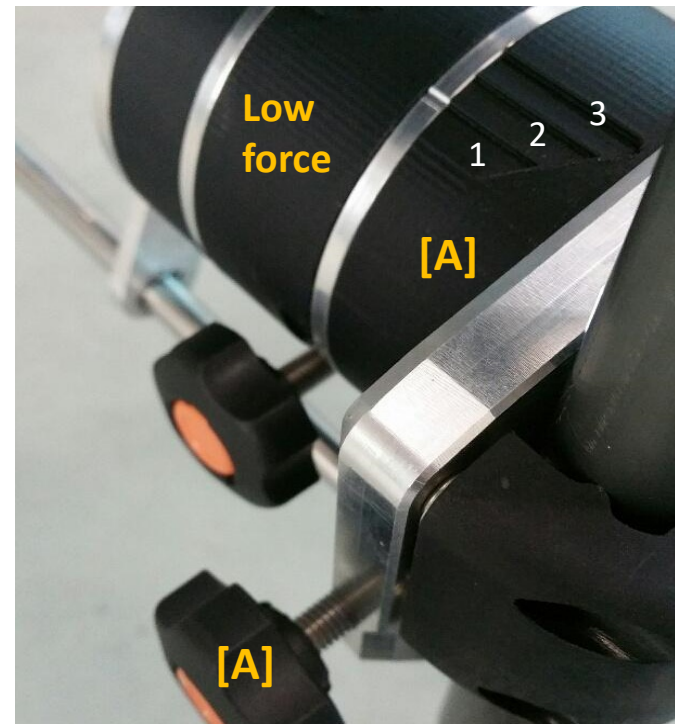

Starting on one side, turn **Knob [B]** to adjust desired lift force which acts when the seat is half elevated; either to low (1), medium (2) or High (3).

Repeat the same to the drum on the right.

Spring force should be adjusted equally on both sides, and typically equally between A & B, before use.

Adjustments should also only be with seat in flipped up position.

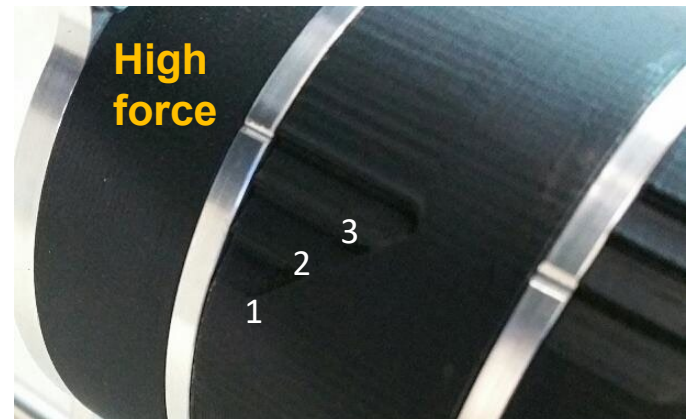
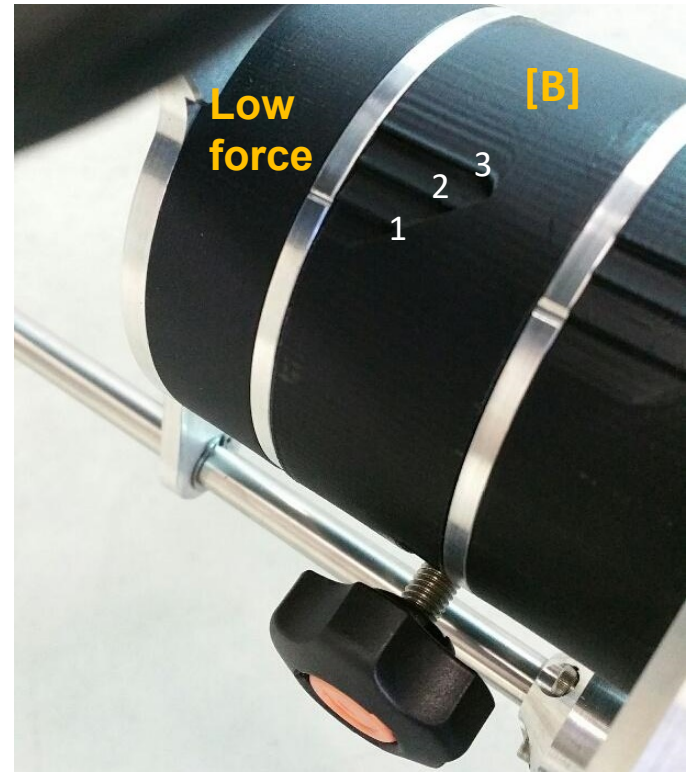

4. Size Adjustments

4.1. Seat Height Adjustment

(for models M1-X, M2-X, L1-X and L-2X with seat; other models do not have seats).

To adjust the Seat Height:

1. Pull the locks out and hold on both sides (left and right).
2. Slide the whole seat assembly up or down, holding on both sides.
3. Release the locks back in the holes on both sides, check both sides are positively locked



Pull the locks out on both sides (left and right).



Lock is not fully engaged into the hole.

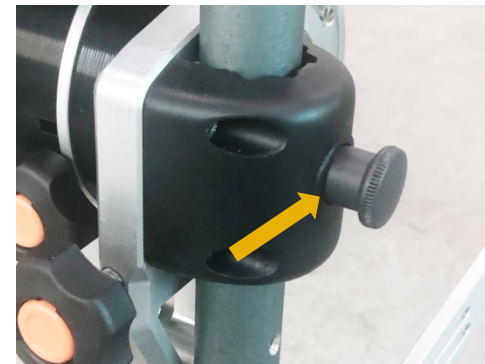

Lock is fully engaged into the hole.

Caution: Please ensure pins are fully engaged before use.

Sliding the seat assembly up or down after unlocking by grabbing at the **black plastic slider part**.



4.2. Forearm Support Adjustment

(for models M1-X, M3-X, L1-X and L-3X with armrests; other models do not have armrest).

Three knobs are used to adjust the Armrests:

- Knob [1] controls the angle and length/extension of the **handle**.
- Lock [2] controls the height of the whole **forearm support**.



Handle Adjustment

To adjust length and angle:

1. Loosen knob [1].
2. Slide handhold forward or backward and rotate to desired position.



Do not extend handles beyond limit mark.



Armrest height adjustment

To adjust height:

1. Pull out lock [2] and hold it in position.
2. Slide post up or down to desired height.
3. Release lock back in, ensuring pin inside has engaged with the hole on the shaft. If not, gently slide the shaft up or down until pin engages.



Fully engaged pin

4.3. Front Wheel Swivel Limit Setting

Swivel limits can be independently adjusted for each individual wheel, and each side of the wheel (lock 1 & 2).

- Position 1: 0° Swivel
- Position 2: 30° Swivel
- Position 3: 60° Swivel

<u>L</u>	<u>R</u>	<u>L</u>	<u>R</u>	<u>L</u>	<u>R</u>
1	1	2	1	3	1
2	2	2	2	3	2
1	3	2	3	3	3

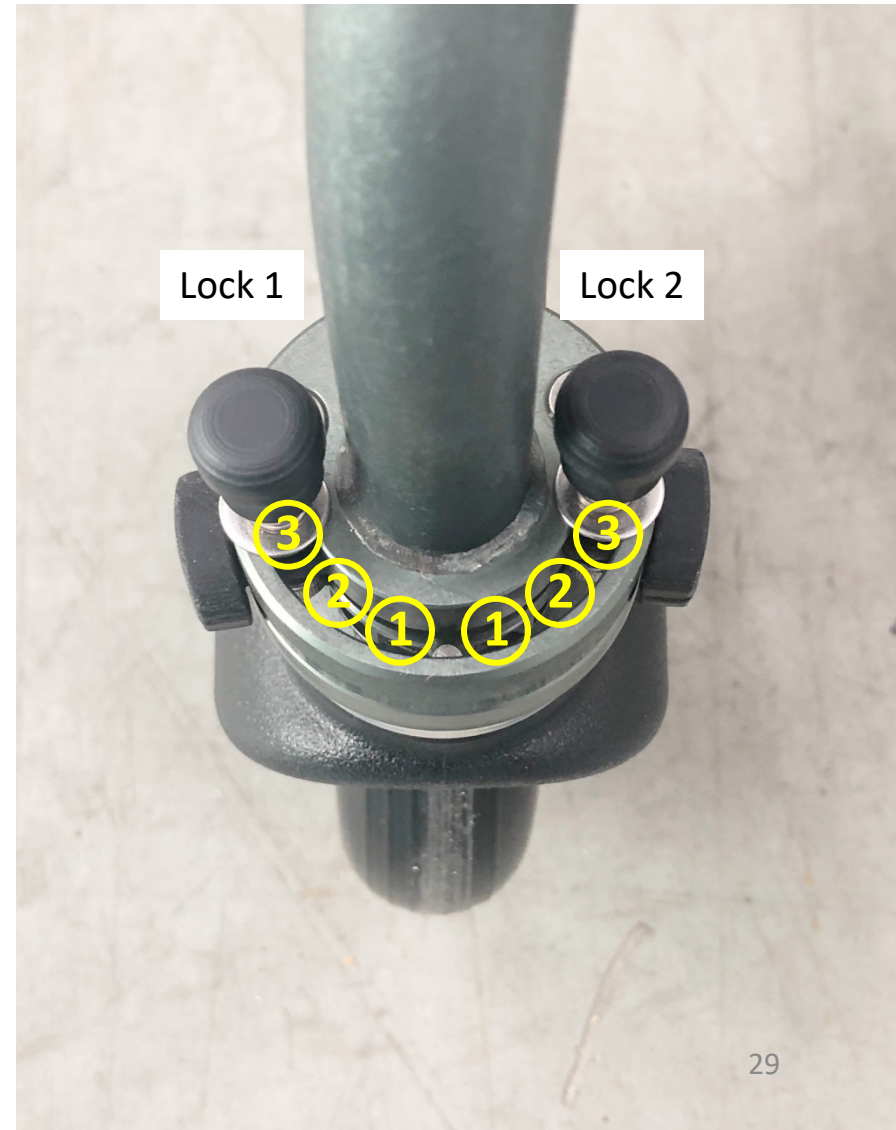

To adjust limits:

1. Push down lock [1].
2. Rotate pin and engage in desired position (1, 2, 3).
3. Release lock 1.

Note: Ensure lock is fully engaged

4. Repeat with pin [2].
5. Repeat with other wheel.



Example Swivel Configurations



Left: 1 Right:1



Left: 2 Right:2



Left: 3 Right:3



Left: 2 Right:3



Left: 3 Right: 1

To remove limits:

1. Unscrew the centering pin
2. Repeat on the other side

Note: Please keep centering pins in case the limit locks should be reinstated at a later time

The front casters can now swivel 360 degrees



4.4. Frame Size Adjustment

Note: Please ensure walker is unfolded , locked & upright, and placed on even ground/surface before adjusting width & height.



4.5. Frame Width Adjustment

An Allen key 2.5mm is required as tool for the frame width adjustment.

1. The frame clamp holds the forward half-frames of the walker together. Loosen the 12 screws (Allen key no. 3) just enough to be able to slide the frames (orange arrows); there is no need to remove them entirely.
2. Slide the left and right half segments in or out relative to the clamp bar (orange double arrows) referring to the markers indicating narrow, medium and wide frame adjustment (red arrows).
3. Re-tighten the screws of the clamp bar, alternating progressively between left and right as well as up and down mirror positions.

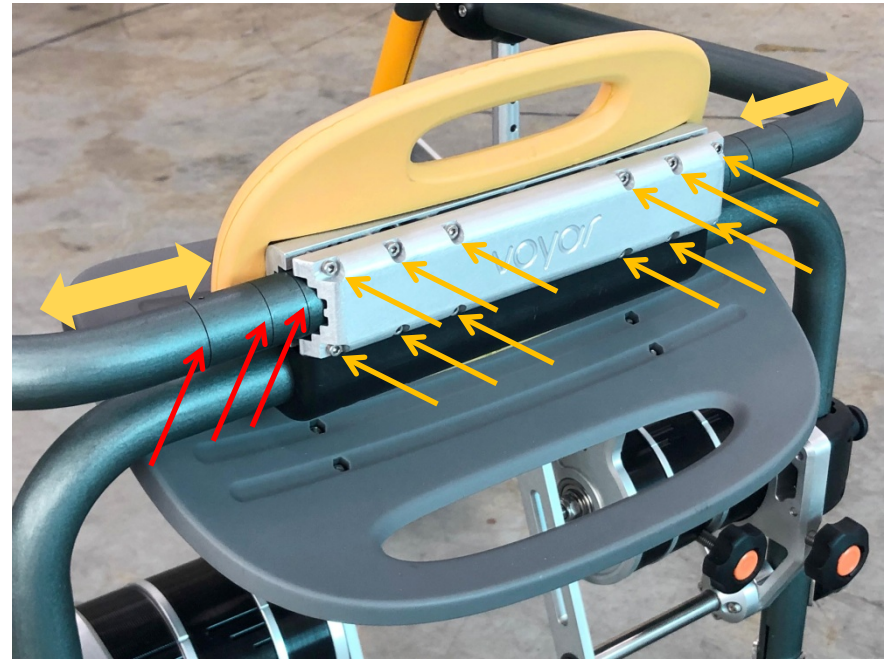

4.6. Frame Height Adjustment

An Allen key 4.0mm is required as tool for the frame height adjustment.

A) Front wheels adjustment

- 1) Starting with one side, locate the clamp screw. With an Allen key, un-tighten it.
- 2) Remove the screw completely
- 3) Slide the wheel attachment inside the frame to the desired incremental position. Check the screw holes line up
- 4) Re-insert the screw and tighten with Allen key
- 5) Repeat on the other front side, carefully checking identical position (count number of holes)



1



2



3



4

A) Rear wheels adjustment

- 1) Starting with one side, locate the clamp screw. With an Allen key, un-tighten it.
- 2) Remove the screw completely
- 3) Slide the wheel attachment inside the frame to the desired incremental position. Check the screw holes line up. Re-insert the screw.
- 4) Tighten the screw with Allen key
- 5) Repeat on the other front side, carefully checking identical position (count number of holes)



1



2



3



4

5. Maintenance and Cleaning

5.1. Maintenance

**After sufficient cleaning, checking for function and defects at regular intervals (approx. 1 month).
If damaged, the relevant parts must be replaced**

1. Check the correct function and locking of the spring plungers on the seat adjustment (2), armrests (2), folding links (2), parking brakes on the rear wheels (2) and steering wheels (4), as well as the clamping screws for the handles on the armrests (2).
2. Check that all screws and nuts are properly tightened.
3. Check for dirt on the wheel hubs, steering bearings of the front wheels and the telescopic lock of the folding lock; clean if necessary.
4. Check the correct function of the seat kinematics with special attention to the condition of the suspension points of the seat.
5. Check the firm and torsion-free condition of the frame width adjustment behind the backrest (screws firmly tightened).
6. Check the condition of the soft moldings (seat, back, armrests, handles) for cracks and breaks.
7. Check the condition of the wheels and tires for wear and damage; check the condition of the wheel bearings (excessive play).
8. Check the plastic fastening parts (black) of the seat module and armrests for cracks, breaks and discoloration.
9. Check the condition of the tubular frame parts for any cracks or bends.
10. Check that the anti-reverse is working properly on both rear wheels when engaged.

5.2. Cleaning

Clean all surfaces and frames with a damp sponge or cloth using soapy water.

If alcohol is required, these painted surfaces should be avoided:

- Seat height fixtures
- Armrest fixtures
- Folding locks

Remove coarse dirt from the wheel hubs.



5.3. Re-use

The Voyar FROG is suitable for re-use. Before a handing over for re-use, the product should be serviced and checked as below. Ideally, this re-processing is carried out by specialist dealers. Depending on the intensity of use, a service life of 8 years can be expected (however, this does not apply to wheels, other wearing parts and soft moulded parts)

1. Before re-use, the instructions for use (which should remain with the product) should be studied in detail.
2. All maintenance points under 5.1 and a thorough cleaning should be carried out.
3. Any deficiencies identified should be corrected. In the case of damage, all affected parts should be replaced (these parts are available from specialist dealers or directly from the manufacturer).
4. All size adjustments and adjustments for the new user should be made by trained or experienced personnel.

6. Specifications

M

Total size

Height (without armrests)	55 - 60 cm
Width	52 - 60 cm
Length	76 - 87 cm

Adjustment ranges

Frame height	46 - 52 cm
Frame width	38 - 46 cm
Seat height	32 - 53 cm
Armrest height	61 - 88 cm

Weight

Base model	5.0 kg
With armrests	6.5 kg
With seat (without armrests)	9.5 kg
With seat and armrests	11.0 kg

User limits

Weight up to	40 kg
Height	90cm – 140 cm

Materials

Frame and seat mechanism	Aluminium and stainless steel
Seat, backrest, armrests, grips	PU foam with armature in stainless steel and aluminium
Fittings	ABS
Wheels	EVA

L

Total size

Height (without armrests)	74 - 81 cm
Width	63 - 82 cm
Length	76 cm

Adjustment ranges

Frame height	67 - 76 cm
Frame width	49 - 57 cm
Seat height	49 - 64 cm
Armrest height	74 - 95 cm

Weight

Base model	6.0 kg
With armrests	7.5 kg
With seat (without armrests)	10.5 kg
With seat and armrests	12.0 kg

User limits

Weight up to	70 kg
Height	130cm – 170 cm

7. Identification

The product label is fixed under the seat. It shows the exact model and the maximum weight of the user.

For models without a seat, it is attached to the rear frame, on the opposite side of the backrest

The serial number is stamped on the rear frame close to the right rear wheel. Please indicate it in the event of complaints or spare parts orders



(Intentionally left empty)

(Intentionally left empty)



XentiQ Partners Pte Ltd

35 Joo Koon Circle, 6th Floor Vicplas Bldg, Singapore 629110



MT Promedt Consulting GmbH

Altenhofstrasse 80, 66386 St. Ingbert Germany

www.voyarmobility.com