

# Molift Quick Raiser 205

**molift**<sup>®</sup>  
by Etac

BM13099 Rev. B 2021-06-09

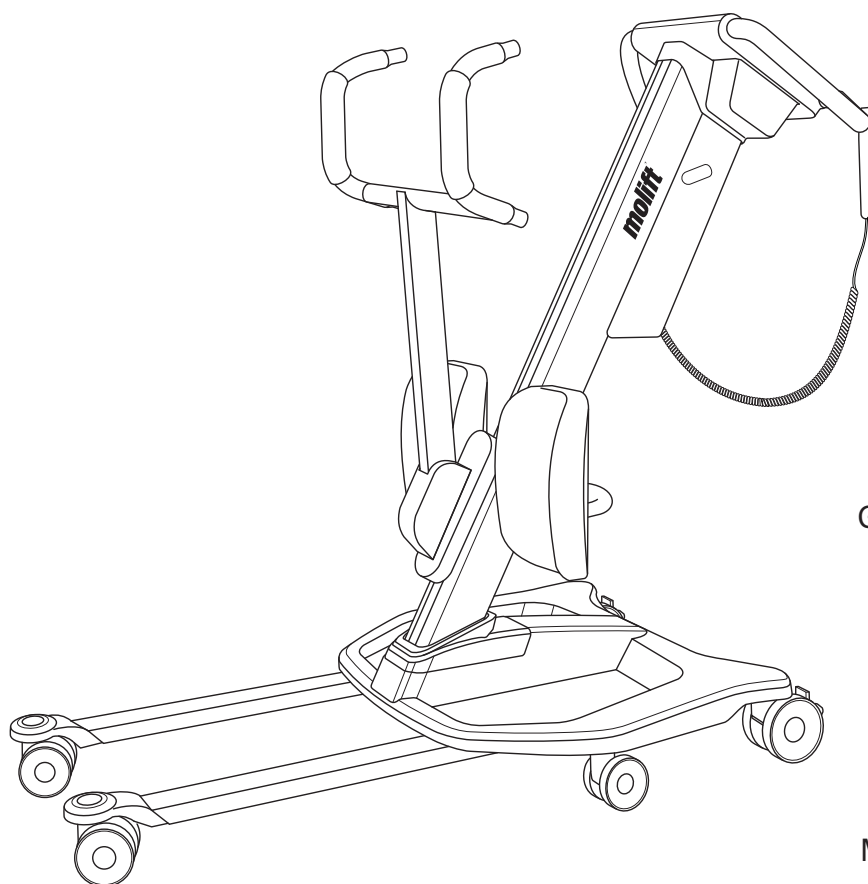

## Contents

User manual - English - 3
Gebrauchsanweisung - Deutsch - 23
Brukermanual - Norsk - 43
Bruksanvisning - Svenska - 63
Käyttöohje - Suomi - 83
Manual utente - Italiano - 103
Manual d'utilisation - Français - 123
Manual de usuario - Español - 143
Handleiding - Nederlands - 163
Brugsvejledning - Dansk - 183



# Molift Quick Raiser 205

EN - User manual

***molift***<sup>®</sup>  
by Etac

BM13001 Rev. E 2021-06-09



# English Manual

## Important

This user manual contains important safety instructions and information regarding the use of the lifter and accessories.

In this manual the user is the person being lifted.  
The assistant is the person operating the lifter.



**Warning!**  
This symbol indicates important information related to safety. Follow these instructions carefully.



**Read User Manual before use!**  
It is important to fully understand the content of the user manual before attempting to use the equipment.

Download documentation at [www.etac.com](http://www.etac.com) to ensure you have the latest version.

*Manufacturer's Declaration can be found in the Molift Quick Raiser Technical Manual (TM13001)*

# Molift Quick Raiser 205

## Components:

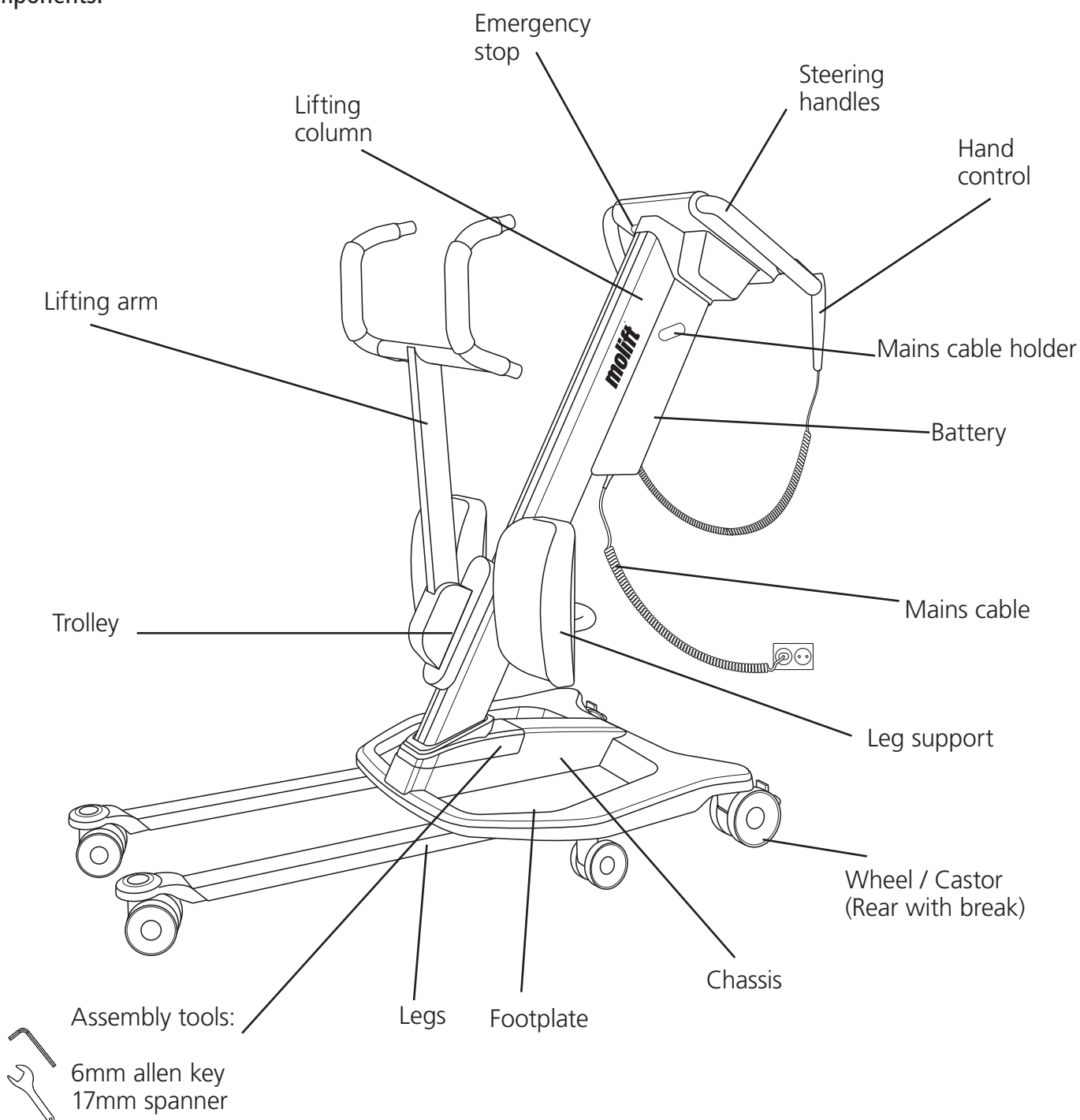

## About Molift Quick Raiser 205

Molift Quick Raiser 205 is a sit-to-stand mobile lifter intended for raising and transferring a person from/to a chair, wheelchair or toilet with a sling. Molift Quick Raiser 205 is intended for users who can follow instructions, have good stability in upper body and can support weight on at least one leg, but needs assistance when standing. The shape of the lifter and geometry of the lifting movement imitates the natural pattern of movement of a person. The lifter is made of light-weight materials, has castors, and an electric

motor powered by a battery. The hoist is operated by using the hand control or the control panel on the hoist. It has electrically adjustable legs and with a lifting capacity of 205 kg (451lbs).

It is ideal for institutional care settings but can also be used in private homes and nursing homes. The lifter should only be used for transfers across short distances, such as between a chair and a bed or into bathroom / rest room, and is not a replacement for wheelchair or similar.

# General

	<p><b>CE declaration</b></p> <p>The product, and its related accessories, described in this instruction for use (IFU), is in compliance with the regulation (EU) 2017/745 of 5. April 2017 – as a medical device, risk class I.</p> <p>The product has been tested and approved by a third party according to standards IEC 60601-1, IEC 60601-1-2 and EN/ISO 10535:2006.</p> <p>Any serious incident that occurs in relation to the device should be reported to the manufacturer and the competent authority of the Member State in which the user and/or patient is established.</p>
---	---

### Conditions for Use

Lift and transfer of a person will always pose a certain risk and only trained personnel are allowed to use the equipment and accessories covered by this user manual.

### Modifications and use of components made by other manufacturers.

We recommend only using Etac Molift components and spare parts. Declaration of conformity is not valid and Etac is not responsible for warranty if any modifications are made to the product. Etac shall not be liable for faults or accidents that can occur when using components made by other manufacturers.

	<p>Only certified personnel are allowed to open lifter or accessories to perform service or repair. Risk of injury from rotating parts and electric shock.</p>
--	--

	<p>The lifter shall not be operated by the person being lifted.</p>
---	---

**Warranty notice**  
 Two-year warranty against defects in workmanship and materials of our products.  
 One-year warranty for batteries.  
 Please refer to [www.etac.com](http://www.etac.com) for terms and conditions.

## Product identification

### Product label / GS1-128

The barcode label contain EAN number, serial number and production date.









(01)XXXXXXXXXXXXXXXX(11)XXXXXX(21)XXXXXX















<b>REF</b> ABCDEFGHIJ			
<b>SN</b> XXXXXX	YYYY-MM-DD		Etac A/S Parallevej 3 DK-8751 Gedved <a href="http://www.etac.com">www.etac.com</a>

**Quick Raiser 205**

Gross weight 249kg / 549lbs  
 SWL 205kg / 452lbs  
 24V DC 7A (SLA), 25.6V DC 7A (LiFePO4)  
 IP24, Duty cycle 10%, 2 min. ON/18 min. OFF



- |   |                                 |   |                         |
|---|---------------------------------|---|-------------------------|
|  | Type BF applied part            |  | Charging indicator      |
|  | CE marked                       |  | Double isolation symbol |
|  | Refer to user manual            |  | Manufacturer            |
|  | Indoor Use only                 |  | Date of manufacture     |
|  | Do not dispose in general waste |  | Catalogue number        |
|  | Emergency lowering              |  | Serial number           |
|  | Service indicator               |  | Medical Device          |
|  | Battery indicator               |   |                         |

### Warning labels and Symbols

Symbols used on the product, explained in more detail:

# Technical Data Quick Raiser 205

**Safe Working Load (SWL):**

205 kg (451 lbs)

**Weight of unit:**

- Total weight of unit: 44,5 kg/98 lbs
- Chassis: 17 kg/37,5 lbs
- Lifting column: 19 kg/41,9 lbs
- Leg support: 3,5 kg/7,7 lbs
- 4-point lifting arm: 5 kg/11 lbs

**Battery:**

- SLA 24V 2.9 Ah
- LiFePO4 25.6V 2.4 Ah

**Battery charger:**

- Input: 100-240 VAC, 50-60 Hz, max 0.35 A
- Output: 29.4 VDC, 0,5 A

**Battery charge time:**

5 hours

**Rated performance:**

100 hoists at: 75 kg and 500mm

**Lifting speed:**

35mm/second (1,4 inches/second)  
with 75kg (165 lbs) load

**Protection class:**

*IP24 (Complete lifter).  
The object, probe sphere of 12.5mm Ø shall not fully penetrate. Water splashing against the enclosure from any direction shall have no harmful effect.*

**Operating forces button:**

- Buttons on control panel: < 5 N
- Buttons on handset: < 5 N

**Material:**

Aluminum, Plastic, steel

**Motor:**

- Lifting motor: 24 V DC
- Leg spreading motor: 24 V DC

**Turning diameter:**

1144 mm / 1300 mm (45<sup>3</sup>/<sub>64</sub> in) / (51<sup>3</sup>/<sub>16</sub> in)

**Expected Lifetime:**

The lifter and accessories has an expected lifetime of 30 000 cycles or 10 years.

**Applied parts:**

- Sling
- Foot rest
- Rocker arm handles

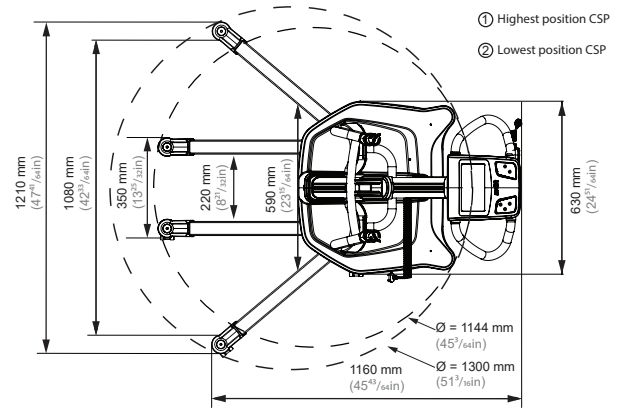
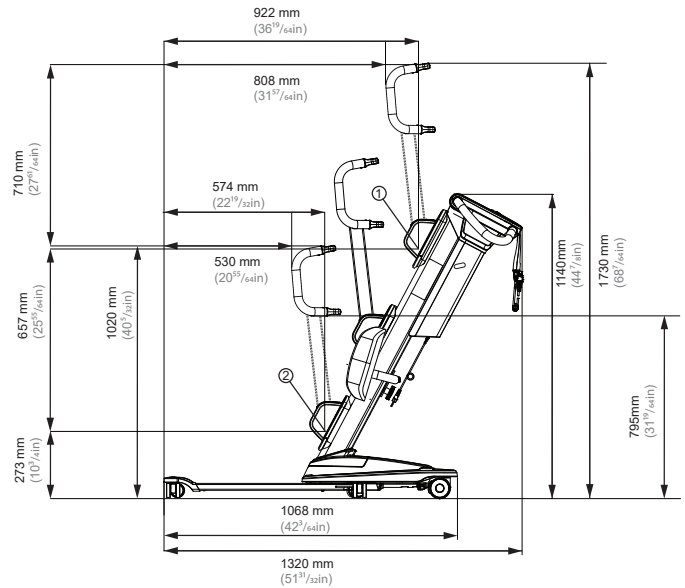

Measurements, QuickRaiser 205 with fixed legs:

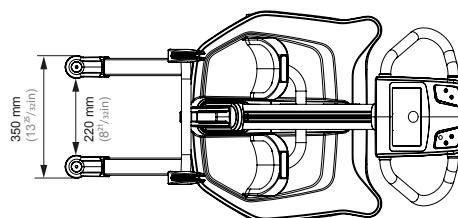
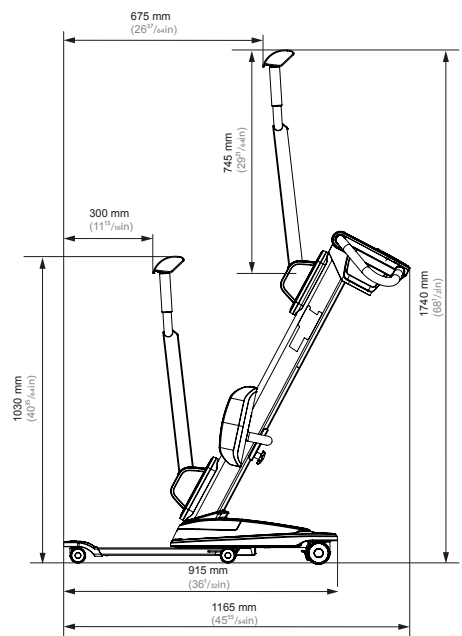

EN DE NO SV IT FI FR ES NL DA

# Assembly Instructions

## Before assembly

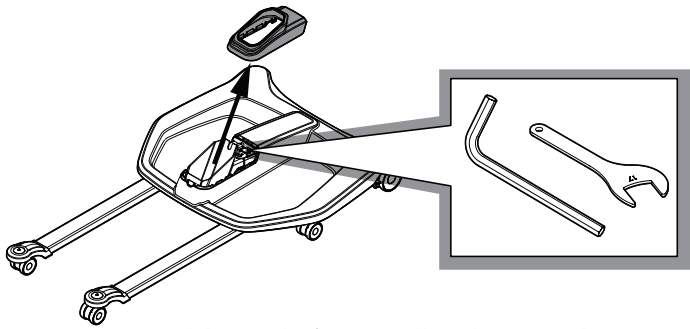

Locate assembly tools (5mm allen key, and 17mm spanner)

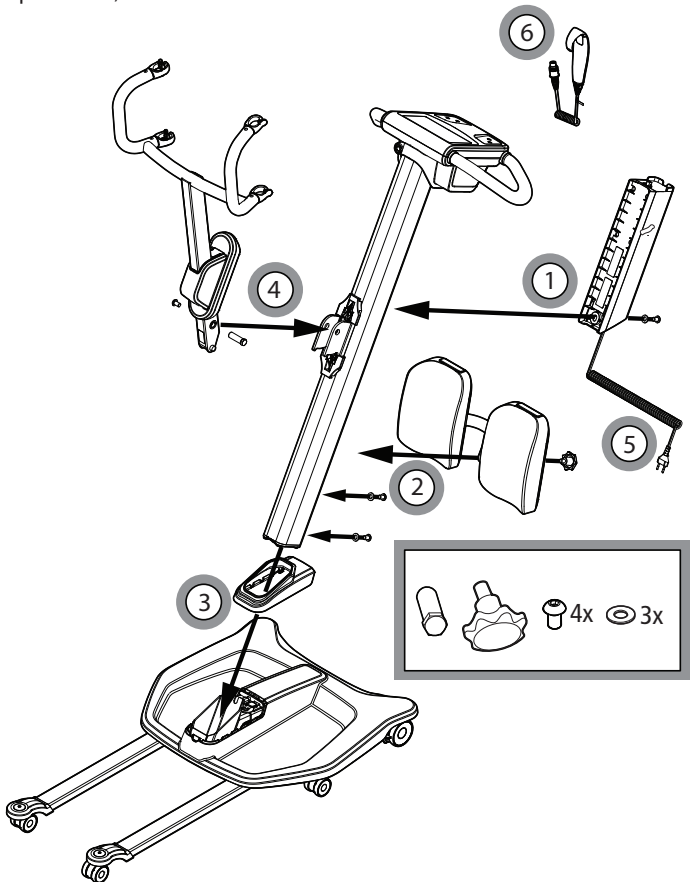

1. Battery
2. Leg Support
3. Column in chassis
4. Lifting Arm
5. Mains cable
6. Hand control

## 1 - Battery

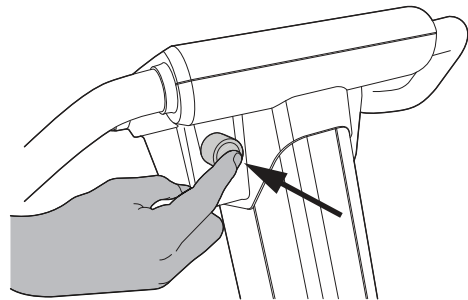

Push in the emergency stop button before assembly

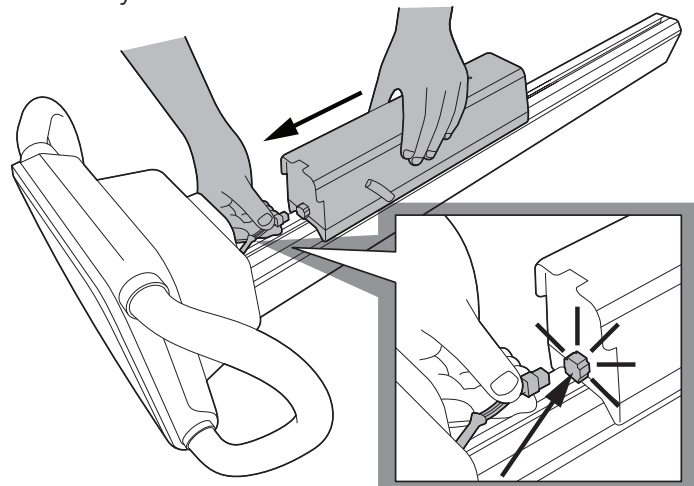

Place the column on a horizontal surface. Make sure the emergency stop is pushed in. Connect wire from control panel to battery box. Slide the batterybox in place.

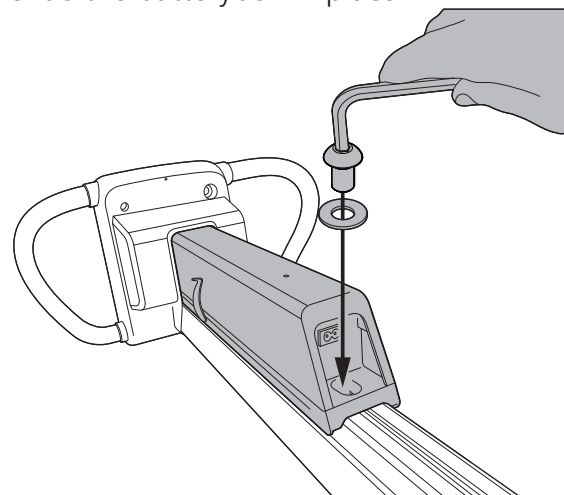

Use the allen key and tighten screw clockwise. NB! make sure to use the washer.

**Only trained personell shall assemble the lifter**

**Make sure the battery is properly fastened before mounting the column in the chassis**

**All screws with pre applied threadlock should only be used once. Spare part art.no 2920075**



## 2 - Leg support

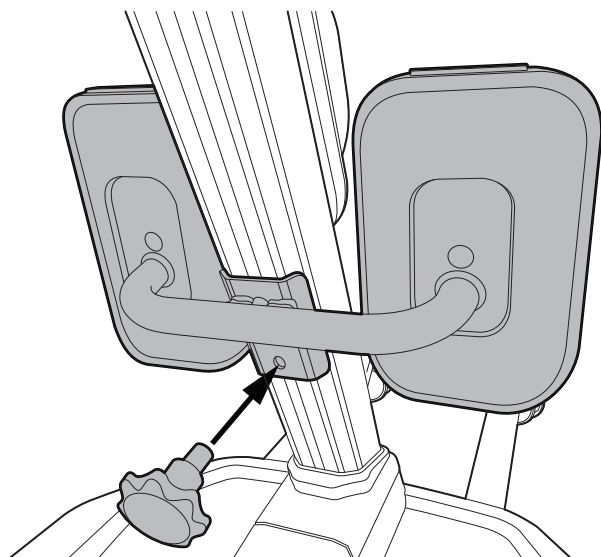

Mount the leg support bracket.

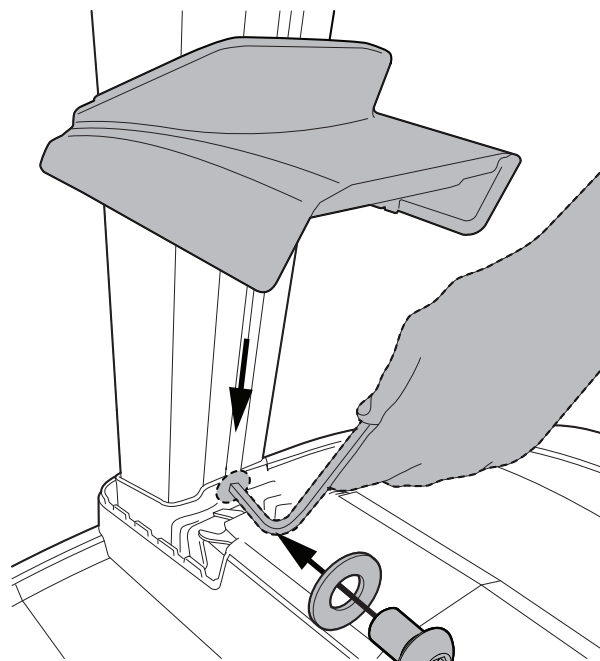

Mount the screw with washer on column. Slide the screw down to chassis, and tighten the screw.

## 3 - Lifting column and chassis

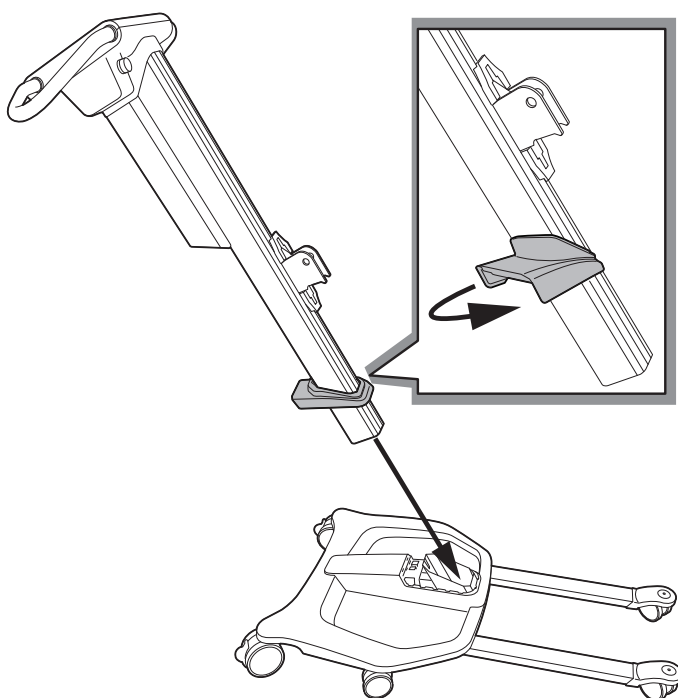

Place the cover on to the lifting column. Twist the cover sideways to make it stay on column. Insert the lifting column into the chassis.

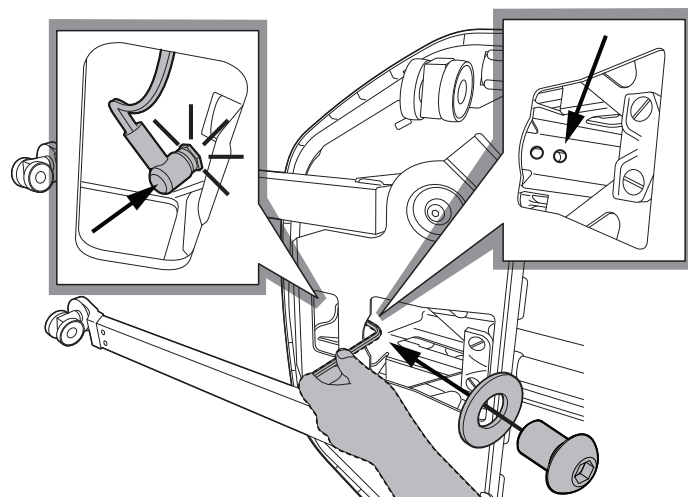

Turn the lifter over on the side. Insert screw and washer in the top hole and tighten the screw. Connect cable between column and chassis. (NB! The cable is NOT applicable with the Molift Quick Raiser 205 FL version)



The screws will ensure that the column cannot be pulled upwards. Do not use lifter unless both screws are securely fastened.

#### 4 - Lifting Arm

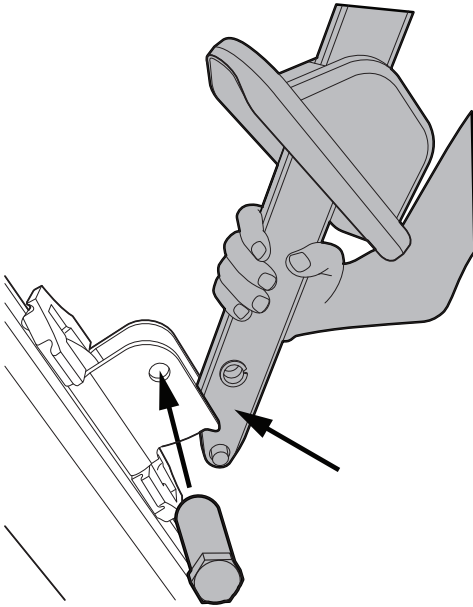

Place the cover onto the lifting arm. Place lifting arm in trolley, and insert the bolt.

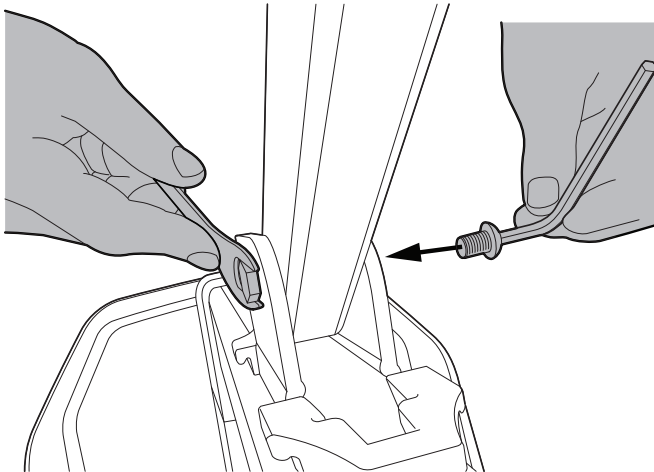

Insert the bolt and tighten the screw using the 17mm spanner and an 6mm allen key. Make sure the lifting arm is properly fastened to the trolley on the column.

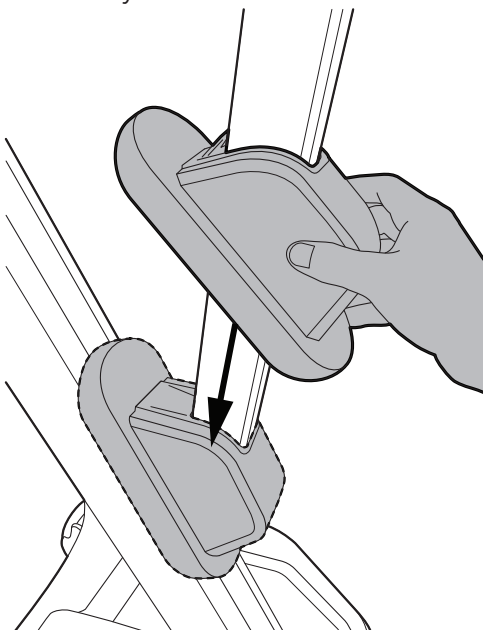

Fit the cover onto the trolley

#### 5 - Mains cable

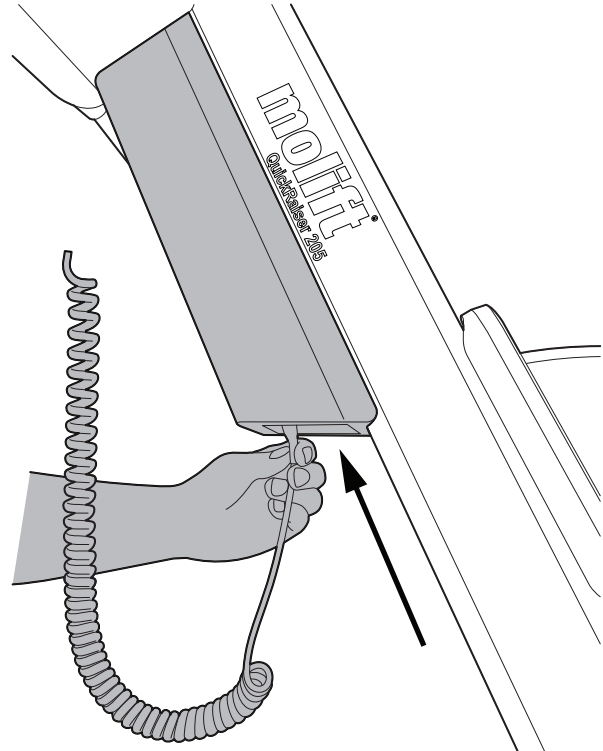

Connect the mains cable to the bottom of the battery box.

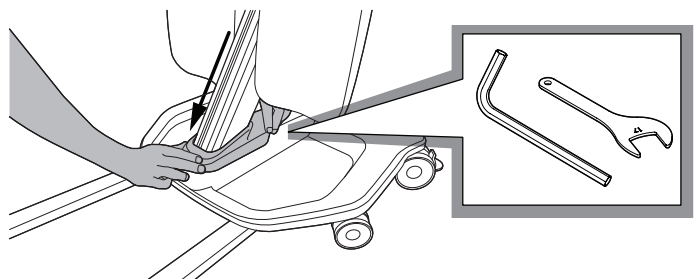

Fit the cover on to the chassis. Remember to put the tools back in place.

## 6 - Hand control

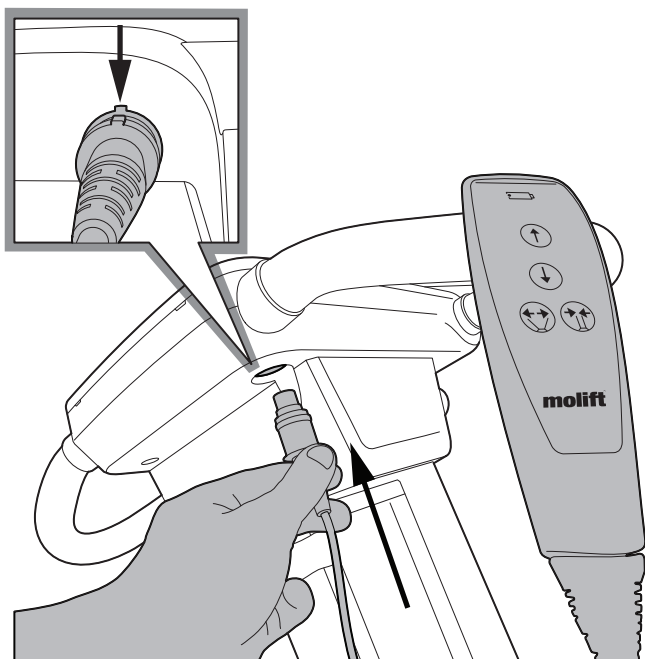

Connect the hand control to the control panel.



**Do not start using lifter before completing control according to checklist after assembly.**

## Checklist after assembly

Use this checklist before use to verify that the lifter is properly assembled and is safe to operate.



**After assembly, reset emergency stop by turning it clockwise. Service light should now be yellow. After completing this checklist, reset service indicator as described in the assembly instructions.**

- Make sure the leg support and lifting arm are properly fixed and that there are no loose parts on the lifter.
- Make sure that the lifting column is properly fixed to the chassis - with both screws tightened.
- Connect lifter to power outlet to make sure integrated battery charger works. Charge battery if necessary.
- Check that the lifter has no apparent damage or other faults.
- Perform one lift with load 50-100 kg  
NB! Lifter will not operate while charging.

## Reset service indicator

If the service LED is yellow, please contact your Molift service partner regarding the necessary measures.

Service indicator will start to be yellow again when 12 months has passed and it is time for periodic inspection.

# How to use Molift Quick Raiser 205

## General Safety Precautions

Only use accessories and slings that are adjusted to fit the user, type of disability, size, weight and type of transfer.

## Working pause ratio/Duty Cycle.

Molift Quick Raiser 205 should not be run constantly for more than 2 minutes (with maximum load), and rest for minimum 18 minutes. Duty Cycle 10%. (Intermittence according to standard ISO-EN 10535)

## Safe Working Load

The lifter is marked with Safe Working Load (SWL)

If maximum load (SWL) differs between lifter suspension and body support unit, then the lowest maximum load shall always be used

Molift lifters shall only be used to lift persons. Never use the lifter to lift or move objects of any kind.

## Before use / Daily check

Inspection to be performed daily or before use:

- Make sure lifter has no visible damage, defects or deformations
- Make sure lifting arm connection, leg support, battery box and all detachable parts are properly connected and secured
- Test emergency stop button
- Check battery level and service indicator
- Make sure sling strap does not have visible damage or frays.
- Make sure wheels are rolling freely and lifter is easy to manoeuvre

- Test run lifters operation functions and make sure lifter does not make any abnormal sounds

If there are any faults or defects, the lift needs to be taken out of operation and marked "out of order"

## Hand control

The hand control has 4 buttons for lifting and lowering of lifting arm and leg spread mechanism in and out.

The hand control has an indicator light that will illuminate when battery level is low and the lifter requires charging

Hand control 4 buttons: Art. no. 2910010  
 Hand control 2 buttons: Art. no. 2910011

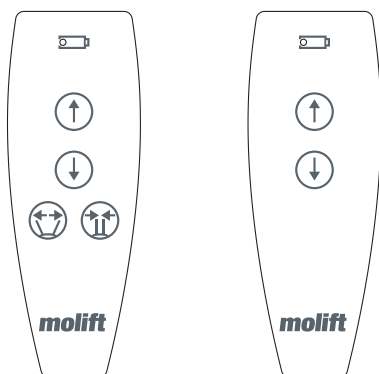

## Lifting Arm - Up / Down

NB! The lifter is most unstable in top position.

## Legs - In / Out

NB! Spreded legs gives increased stability and better access to chair or toilet.

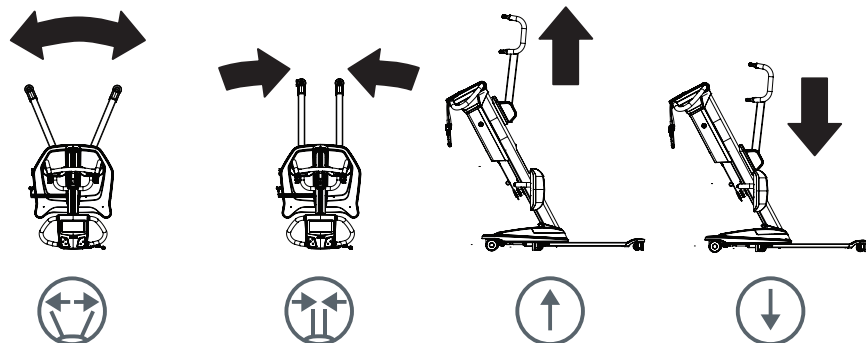

## Safety devices

Molift Quick Raiser 205 is equipped with several safety devices, which are intended to prevent injury to personnel or damage to the equipment in the case of incorrect use or failure

The lifter has an overload sensor preventing the lifter to be operated if the load exceeds SWL.

The suspension is hinged to prevent the arm and suspension from squeezing the user.

## Steering handles

Use the steering handles to move the lifter.



**Do not push or pull the user, lifting column or lifting arm. This may cause stability problems and lifter may tip over.**

The lifter shall only be used for transfer over short distances. It is not a replacement for wheelchair or similar.

## Brakes

Rear wheels/castors are equipped with kick brakes. Step on the break to lock brakes. Push up or kick on top part of the brake to unlock.

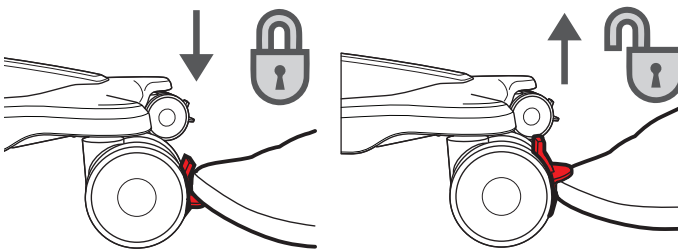

## Emergency stop / Emergency lowering

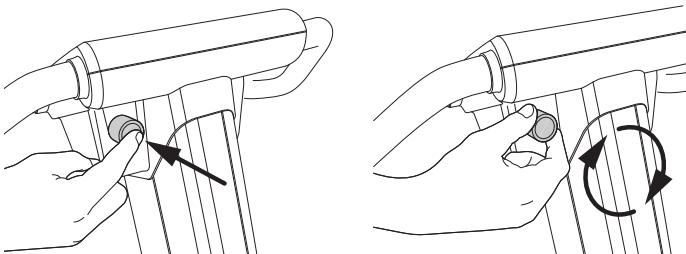

### Emergency Stop

The emergency stop shuts off the power when pushed in. Turn clockwise to reset.

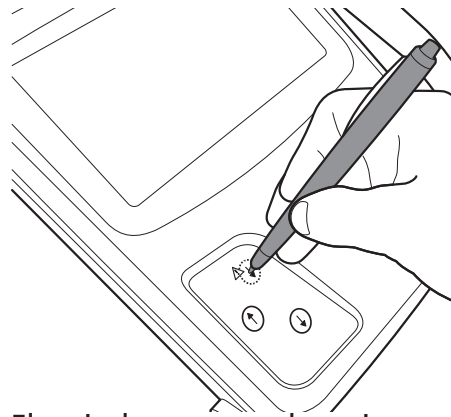

### Electrical emergency lowering

Use a pen or sharp object to push and hold button for electrical emergency lowering to lower suspension. The electrical emergency lowering function does not work when the emergency stop is activated.



**Only use the electrical emergency lowering if no other button works.**

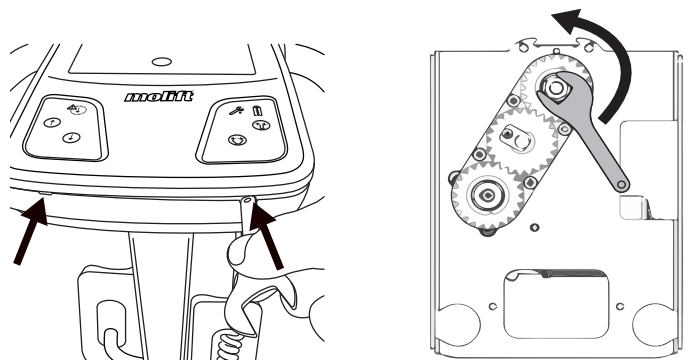

### Manual Emergency lowering

Use the wrench located in the bottom cover to flip the control panel cover off at the two points.



**Push in the emergency stop button before removing the cover. Rotating parts represents a squeezing hazard!**

Use the 17mm spanner and turn ball screw counter clockwise until the user is safely lowered. The manual emergency lowering function should only be used when the electrical emergency lowering does not work.



**If emergency lowering is used, mark the lifter "out of order" and order service!**

# Electronics

## Transport and operating conditions

### Transport and Storage

For long time storage it is recommended that the emergency stop button is activated (pushed in). The lifter can be stored and transported under temperatures between -25 - 70 °C.

### Operating

The lifter is designed for use at standard room temperatures (+5 to +40°C).  
 Air Pressure: 70 - 106 kPa  
 Relative Humidity: 15 - 93 %  
 Storage or transport at other temperatures leave the lifter in a room with a suitable temperature until it reaches a safe operating temperature.



**Medical electrical equipment requires special precautions regarding electromagnetic compatibility (EMC). Portable or mobile radio communication equipment may affect the medical electrical equipment, and should be kept minimum 25 cm (10 inches) from the lifters electronics.**

## Battery

Molift Quick Raiser 205 is available with a 24V SLA battery or a 25.6V LiFePO4 battery - both with an integrated charger.  
 The SLA battery has a life expectancy of approx. 500 charge cycles.  
 The LiFePO4 battery has a life expectancy of approx. 2000 charge cycles.





**Recharge battery upon receipt, and then every six months, to avoid battery failure.**



**Batteries must be disposed of as special waste according to local rules and regulations. Do not dispose in general waste**





## Battery and Service indicator

	Wrench symbol / Service indicator
	Battery symbol / Battery indicator

The electrical system has a power-save function which will turn off the electrical system five minutes after last operation. All indicators will turn off. The system is activated when pushing one of the operating buttons

### Battery indicator on control panel

When the multi level battery indicator is yellow the lifter will have sufficient power available for one full lifting cycle with max load. When battery is flashing yellow it is only possible to lower the lifting arm.

<i>Battery indicator</i>	<i>Battery level</i>	
	Green	80% or more
	Green	80 - 60%
	Green	60 - 40%
	Green	40 - 20%
	Yellow or yellow blinking	20% or less (recharge lifter)

## Service indicator

The lifters electronics record the weight lifted and number of lifts. After a certain period of operation a signal is given to indicate that service is required.

### Service indicator (from 01.01.2018)

<i>Service light</i>	<i>Mode</i>
No light	No service needed
Green flashing	Order service
Yellow	Periodic inspection required
Red	Perform service

### Service indicator (up until 31.12.2017)

<i>Service light</i>	<i>Mode</i>
No light	No service needed
Yellow	Order service
Yellow flashing	Periodic inspection required
Red	Perform service



Do not position lifter in a way that makes it difficult to disconnect mains cable



Do not charge the lifter in a bathroom or in any room with wet surfaces!



Remove the main cable from the wall socket outlet before moving the lifter

## Charging

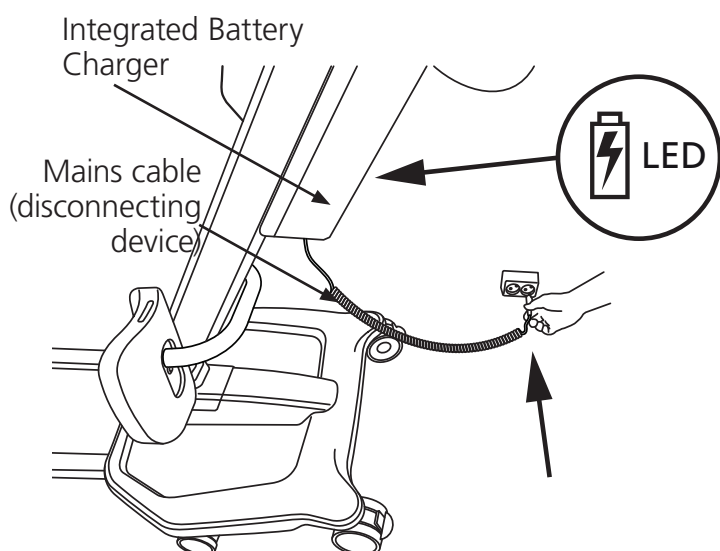

The lifter has an integrated charger. Park the lifter and connect to a wall socket to charge the battery. A LED-light on the back of the battery box will be red while charging. The LED-light on the battery box will show a steady green color when lifter is fully charged. While charging the LED-lights on the control panel will flash every 10 seconds.

# Transfer

Plan the lifting operation in advance to ensure that it is as safe and smooth as possible. Remember to work ergonomically. Assess the risks and take notes. The assistant is responsible for the safety of the user.

## Using Slings

It is important that the sling has been tested with the individual user and for the intended lifting situation.



**Read User Manual for the sling prior to use.**



**Do not to use damaged or badly worn slings.**

**Slings made by other manufacturers**  
 Only use Molift slings. Etac shall not be liable for faults or accidents that can occur when using slings made by other manufacturers.

## Adjusting leg support

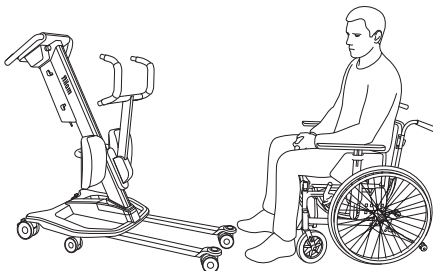



Move the Quick Raiser 205 in front of the user. Place the feet on the footplate. If necessary - help the user to place the feet correctly. Lock the wheels on the lifter before lifting the user. The optimal angle of the users joints before lifting is 90 degrees.

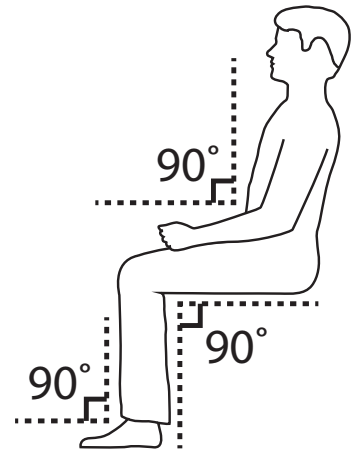
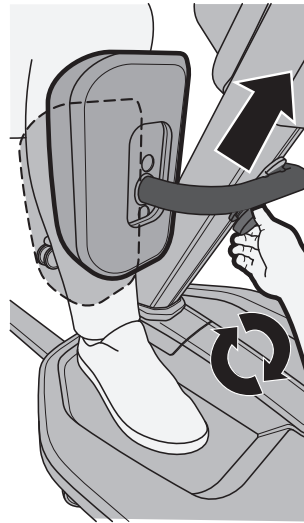

**Make sure the height of the leg support are adjusted to fit the individual users anatomy. The top of the cushions should be 2 cm under the users knee**

Use the turning knob to adjust the leg support higher or lower if necessary.





**Make sure the user is not hanging forward or swinging to the sides under and before lifting or lowering the user.**

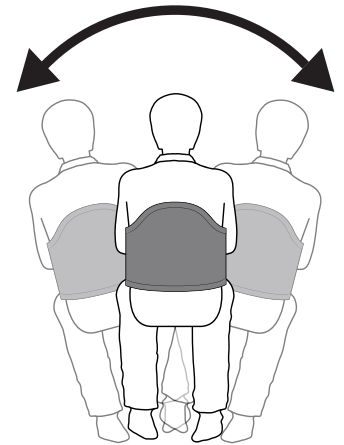

## Alternative leg support with straps

The alternative leg support with straps can be removed and turned 180 degrees to increase support on both inside or outside of the users legs.

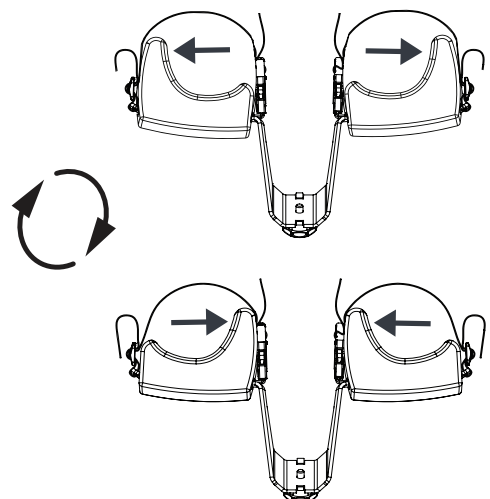



## Using a 4-point suspension

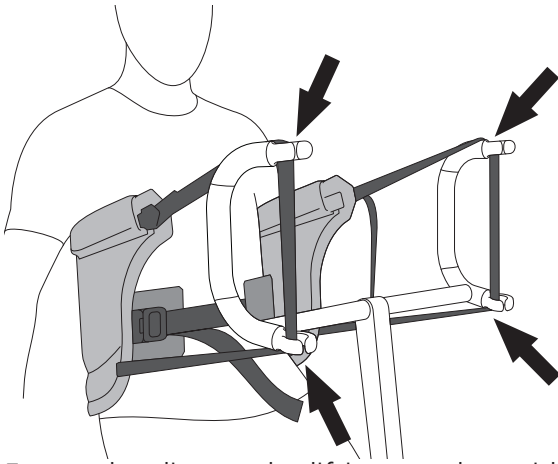

Fasten the sling to the lifting arm by guiding the strap into all 4 hooks.

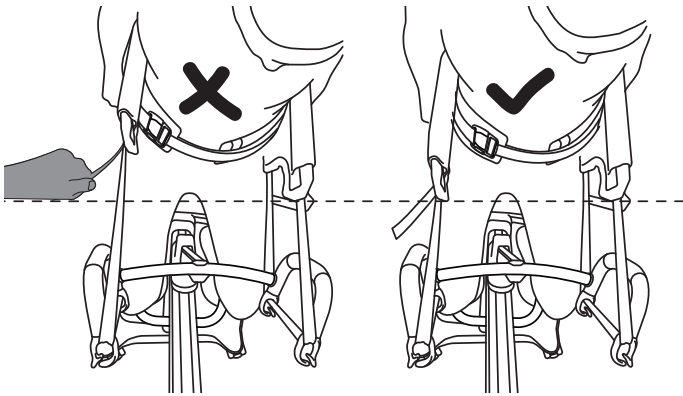

Pull the loose strap to adjust the length of the straps. Make sure both sides have equal length.

The patient's weight ensures that the strap locks into the lifting arm. The user must lean back slightly when lifting, and if possible hold onto the handles.

## Removing sling

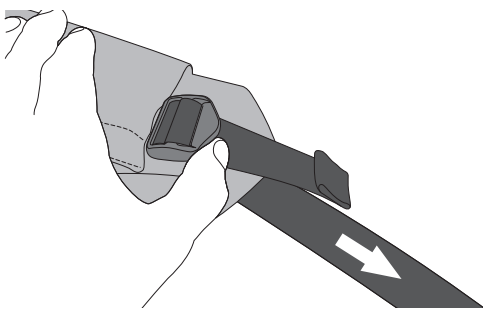

Loosen the straps again by angling the buckle and pulling the strap out.

## Using a 2-point suspension

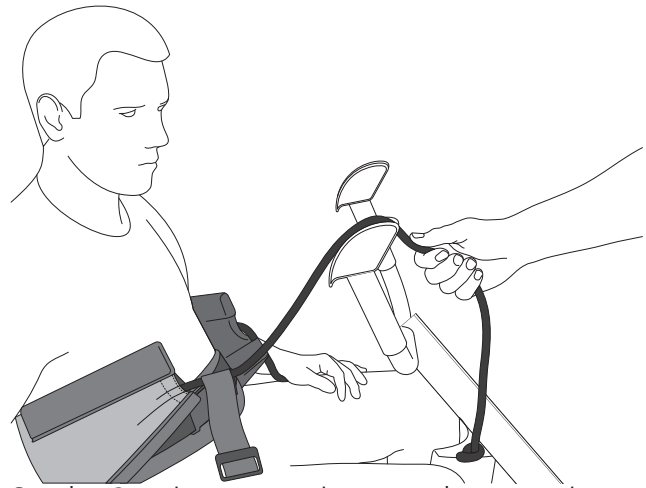

On the 2-point suspension arm the ropes is attached to the lifting arm by pulling them firmly from above and into the rope locks.

## Removing sling

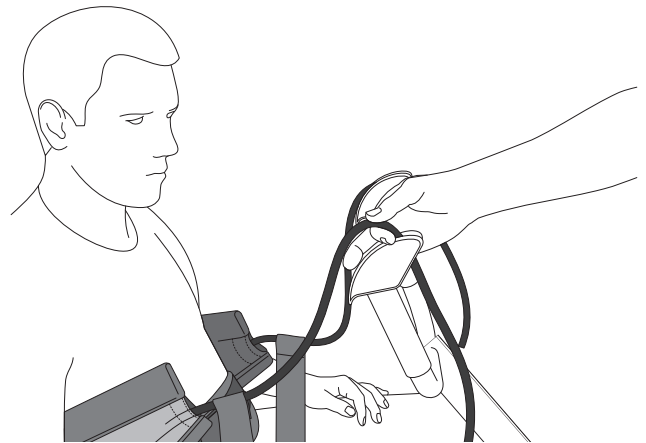

Release the band by sliding your fingers along the rope away from the patient.



**RgoSling Active can only be used with the 4-point suspension.  
RgoSling Stand Up can only be used with the 2-point suspension.**

## Raising/Lowering

When moving the user, stand to the side of the person you are lifting. Make sure that arms and legs do not obstruct the seat, bed, etc. Keep eye contact with the user to help them feel safe.

If possible: Extend the width of the wheel base prior to lifting using the button for base width adjustment on the Hand control.

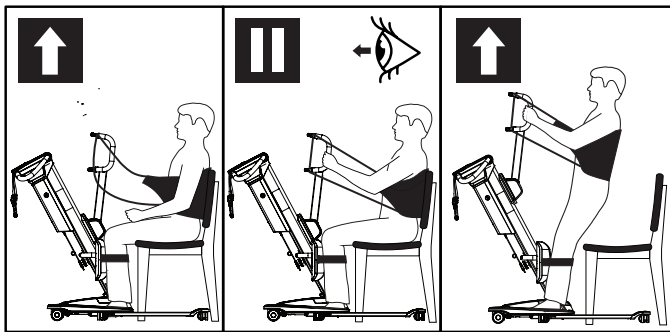

1. Check that the sling is correctly fitted around the user and that the strap loops are correctly fitted to the suspension hooks.
2. Make sure user has both feet placed firmly on the footplate on the lifter.
3. Stretch the sling straps without lifting the user. Ensure that both loops of the sling are securely fastened to avoid the user slipping or falling.
4. Make sure the buckle is properly fastened
5. Lift user to standing position, and tighten and adjust the sling if necessary.

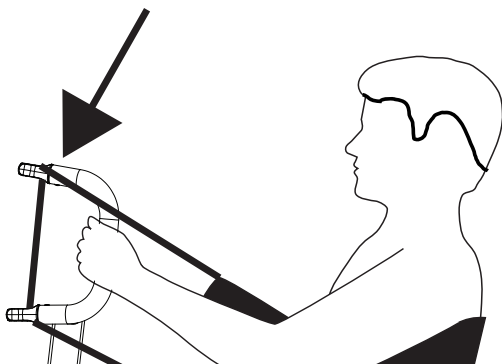

**Make sure the users hands are placed correctly to avoid that the lifting straps are squeezing the users hands and fingers.**

NB! The wheels of the object the user is being lifted from or into must be in the locked position.

## Transfer

Raise the patient carefully until the buttocks are clear from the seating and tighten the belt. Unlock the wheels on the lifter and move the patient to the next location.

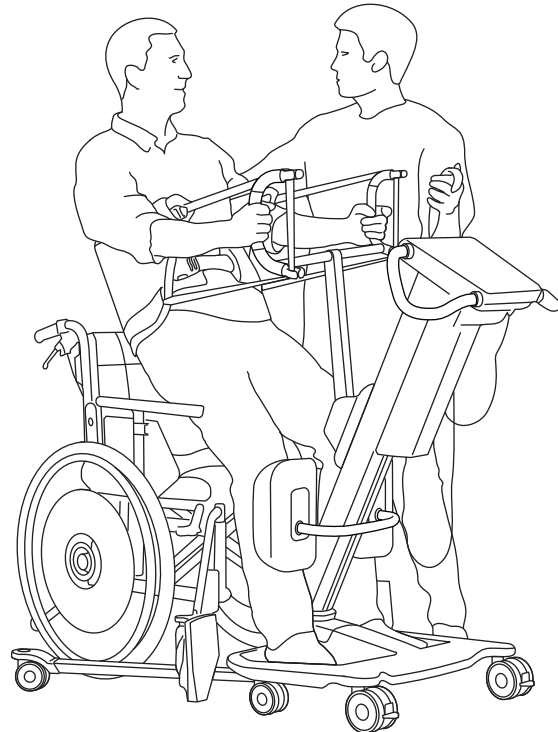

Be careful during movement not to run into furniture, walls, doors etc.



**The lifter shall not be used to lift or move users on sloping surfaces**

Avoid deep pile carpets, high thresholds, uneven surfaces or other obstacles that may block the castors. The lifter may become unstable if forced over such obstacles increasing the risk of tipping over.

The lifter shall only be used for movement over short distances. It is not a replacement for wheelchair or similar.

## Accessories

(Recommended) optional equipment and accessories for Molift Quick Raiser 205.

### Accessories

Extension for power cord  
Art. no.: 2920117

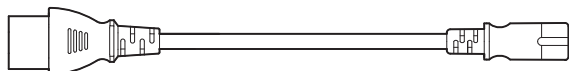

Set of inlay for footplate  
Art. no.: 2920151

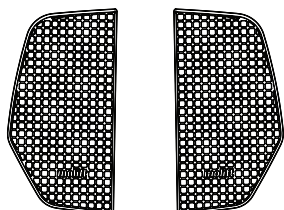

Footboard  
Art. no.: 2910065

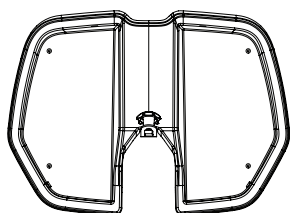

Alternative leg support with straps:

Complete kit with bracket and large cushions

Art.no.: 2910056

Set of large cushions

Art.no.: 2910077

Complete kit with bracket and small cushions

Art.no.: 2910059

Set of small cushions

Art.no.: 2910076

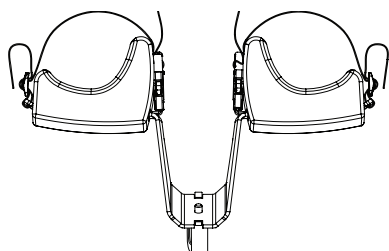

### Lifting arms and slings

4-point suspension:

Quick Raiser Active lifting arm  
Art. no.: 2910060

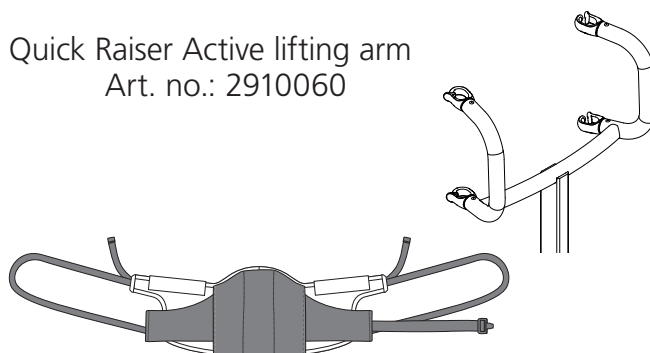

Rgosling Active

Art. no.: 1720910 Size XS

Art. no.: 1720920 Size S

Art. no.: 1720930 Size M

Art. no.: 1720940 Size L

Art. no.: 1720950 Size XL

2-point suspension:

Quick Raiser Stand Up lifting arm  
Art. no.: 2910061

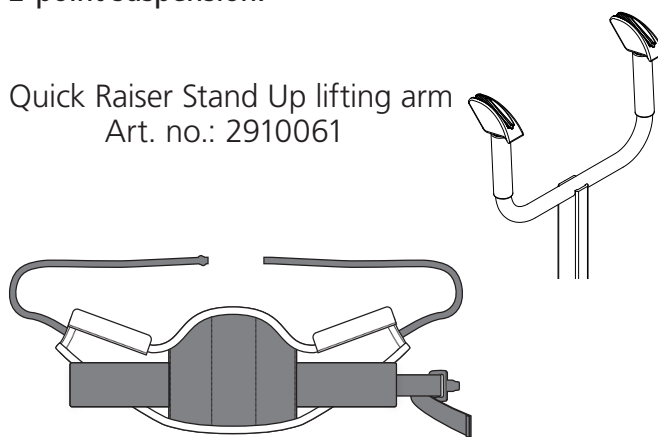

Rgosling Stand Up

Art. no.: 1720710 Size XS

Art. no.: 1720720 Size S

Art. no.: 1720730 Size M

Art. no.: 1720740 Size L

Art. no.: 1720750 Size XL

Rgosling Stand Up Padded

Art. no.: 1720810 Size XS

Art. no.: 1720820 Size S

Art. no.: 1720830 Size M

Art. no.: 1720840 Size L

Art. no.: 1720850 Size XL

## Maintenance

### Cleaning and disinfection

Clean on a regular basis. Clean surfaces with a damp cloth using an appropriate pH-neutral detergent. Do not use solvents or strong liquids, this may damage surfaces on the lifter. For disinfection when needed; use isopropyl alcohol. Avoid abrasive cleaning products.

- Remove lifting arm cover to clean underneath
- If necessary, remove the knee cushion and clean it with running water
- Remove hair and pile from the castors and verify that the castors rotate freely.

Clean contact and hand control with isopropyl alcohol to remove grease and dirt if necessary. Check emergency stop after cleaning. The lift should not be exposed to running water.



Make sure not to damage or remove labels when cleaning.

### Reconditioning

Follow cleaning and assembly procedure, complete periodic inspection and use checklist after assembly to recondition the lifter.

### Recycling

Refer to "Recycling instructions" for how to properly dispose of product. See [www.etac.com](http://www.etac.com).

### Spare Parts

A list of spare parts is available on request.

## Periodic Inspection

### Periodic Inspection Scope

Periodic inspection is a visual examination (particularly of the lifter's load bearing structure and lifting mechanism with attachments, brakes, controls, safety devices and person-support devices) according to Periodic Inspection Report for Molift Quick Raiser 205.

See [www.etac.com](http://www.etac.com).

When performing a periodic inspection, the inspector shall fill out the inspection report for Molift Quick Raiser 205. The reports should be retained by the person(s) responsible for servicing the lifter. If the inspection reveals defects and damages, the lifter shall be taken out of operation and marked "out of order" until it is repaired. After performing periodic inspection reset the service indicator, see page 11



If there is any problems with the lifter that could jeopardize someone's safety, the lifter shall immediately be taken out of service and marked "out of order". Do not use the lifter until it is repaired.

Periodic Inspection shall be performed at least once a year or more frequently if required by local requirements. The inspection must be performed by service personnel authorized by Etac. Contact Etac at [molift@etac.com](mailto:molift@etac.com) for training and authorization or recommendation of an approved service partner.

## Troubleshooting

Symptom	Possible Cause/Action
The lifting column is wobbly	Locking bolts are not properly secured or lifting column is not properly in place in the chassis / check if the column is correctly placed in the chassis and/or tighten bolts
Lifter only moves one way (up or down) / legs only moves one way (in or out)	Fault on hand control / exchange with alternative control from other lifter and/or new hand control
	The electronics has failed / contact your local service representative
The lifter moves up and/or down by itself / legs move by themselves	Short circuit between the hand control and lifter / clean the connectors of the hand control and chassis with spirits to remove grease and dirt
	The hand control has failed/ exchange hand control / contact your local service representative
	Relays/electronics malfunctions / exchange electronics/relays / contact your local service representative
The lifting arm does not move / legs does not move	Discharged battery / charge battery
	Emergency stop activated / turn clock wise to reset
	Hand control disconnected / reconnect hand control
	The hand control has failed/ exchange hand control / contact your local service representative
	Electronics malfunctions / contact your local service representative
	Motor has failed / contact your local service representative
	Check contact between column and chassis