



User manual

Star StabilAir and Star Standard Air



1a17738 - 2026-04-14 - Version 9

en sv no da de fi fr nl it es pt hr pl is sl



7-8 8-9 9-11 11-12 12-14 14-15 15-16 16-18 18-19 19-21 21-22 22-24 24-25 25-27 27-28

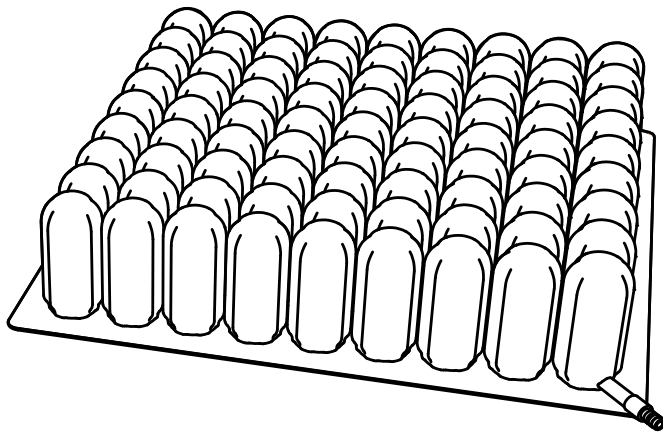

Star StabilAir 7.5 cm/3"

Star StabilAir 10 cm/4"

Star Standard Air 5 cm/2"

Star Standard Air 7.5 cm/3"

Star Standard Air 10 cm/4"

A

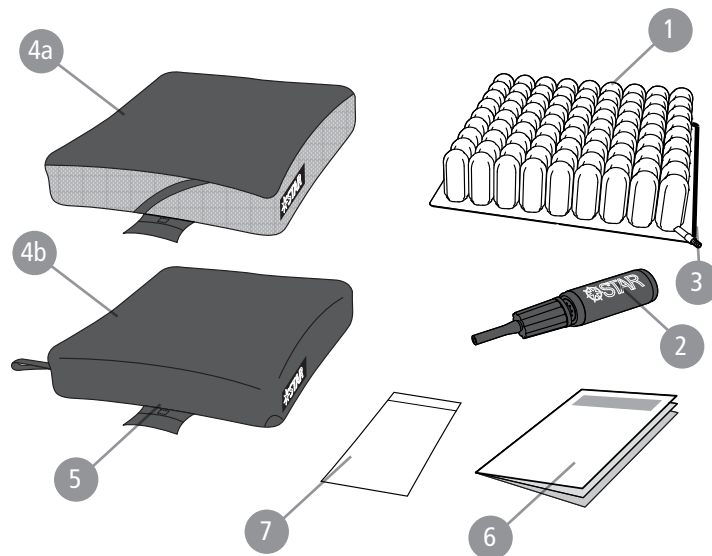

en sv no da de fi fr nl it es pt hr pl is sl



www.etac.com



B

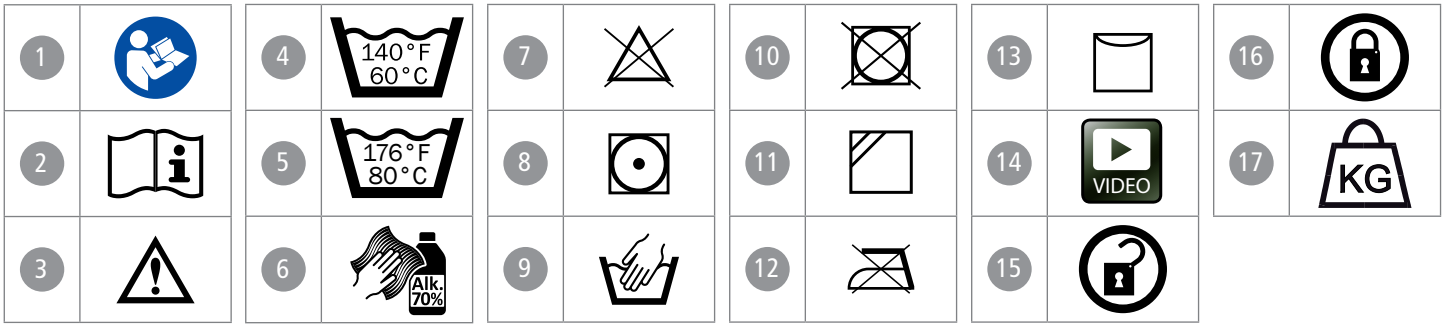

C

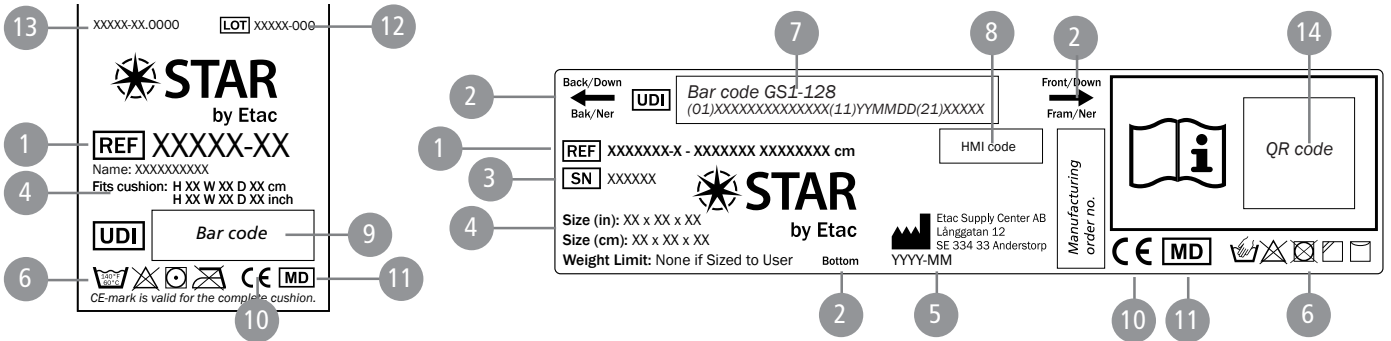

D

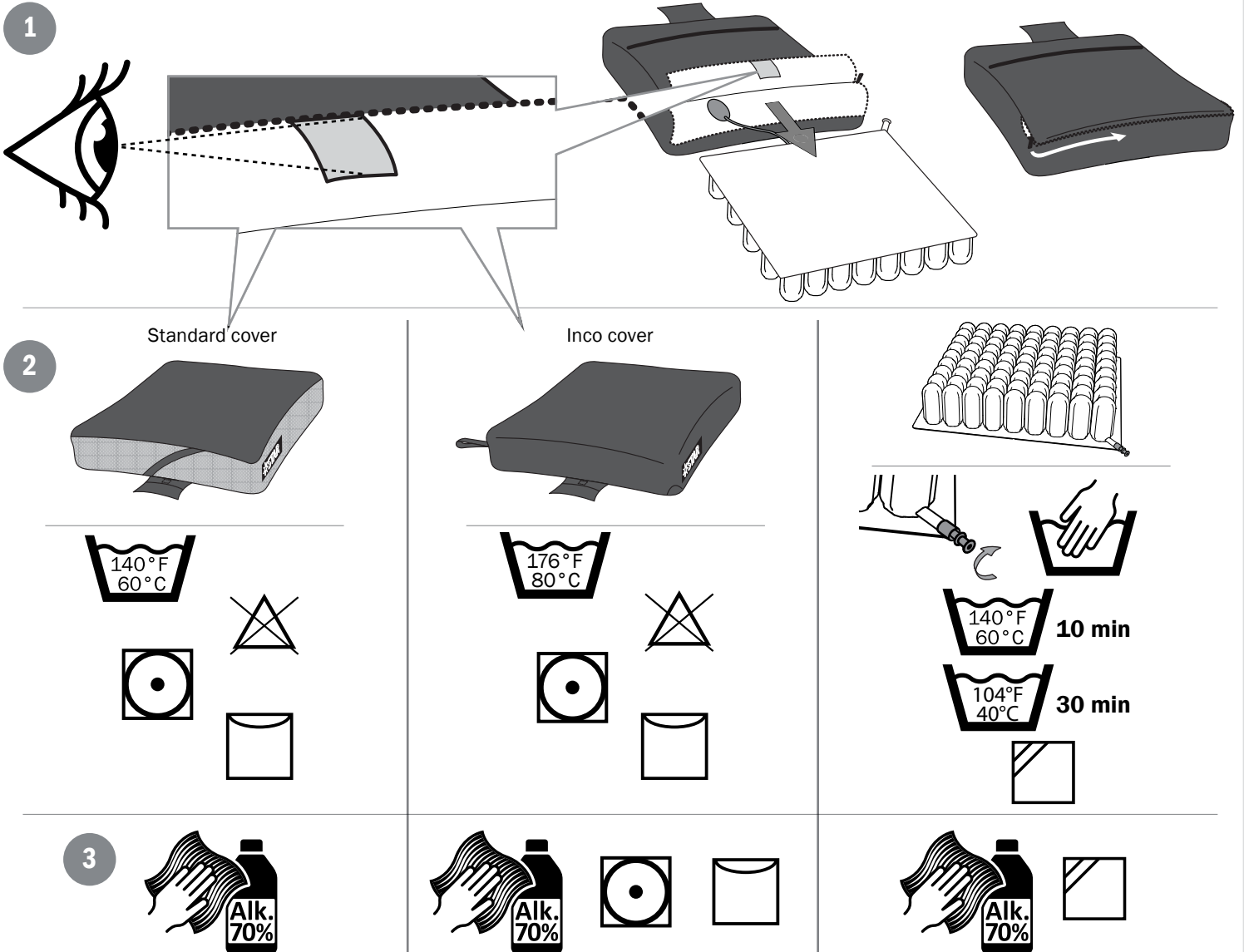

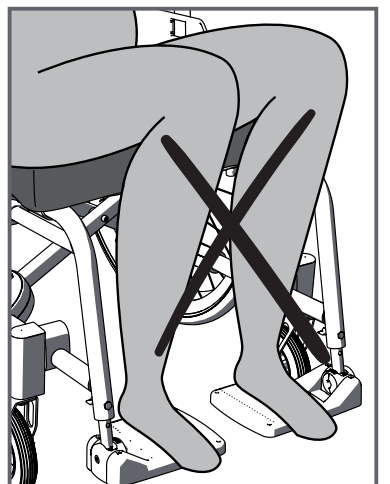
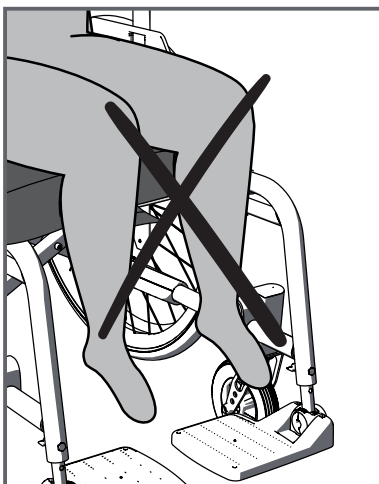
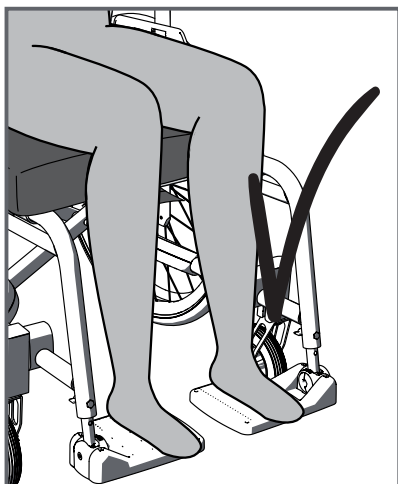
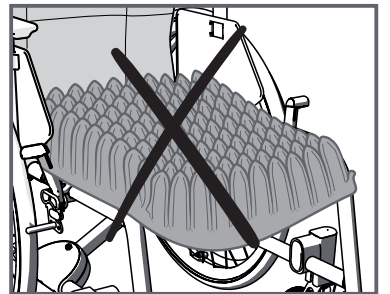
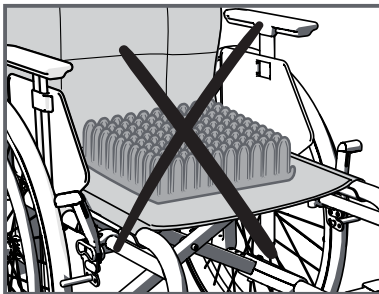
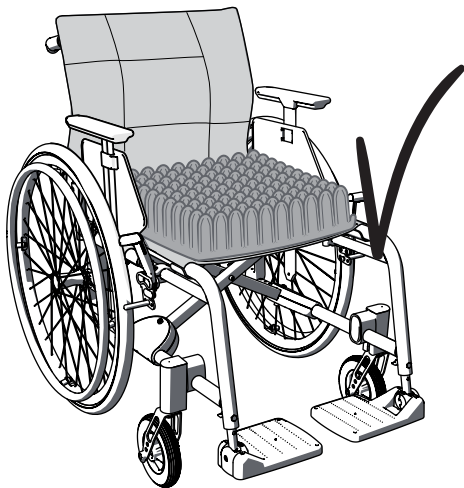
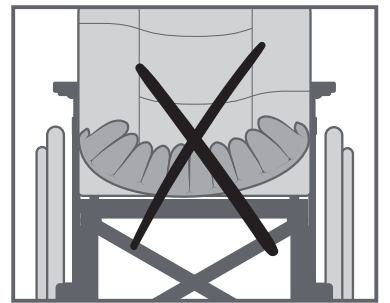
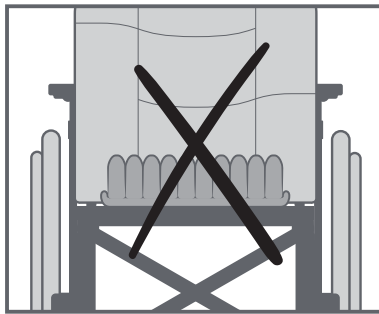
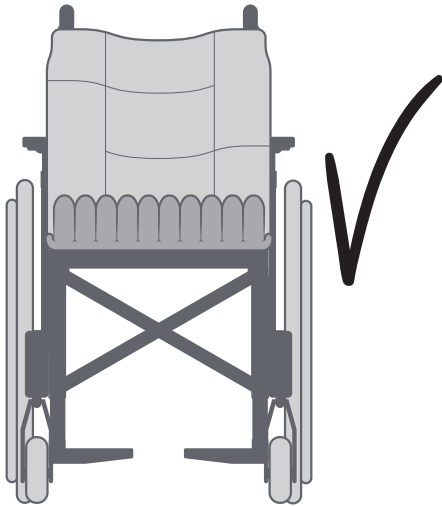
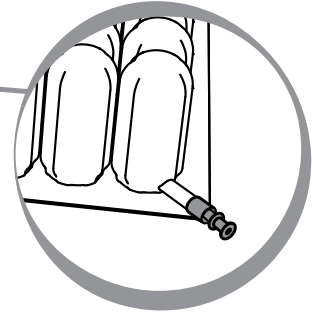
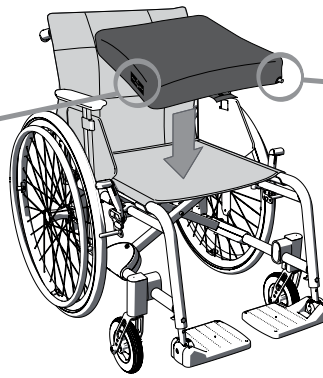
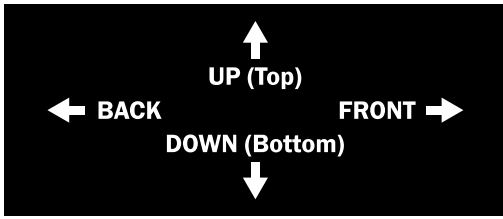

1

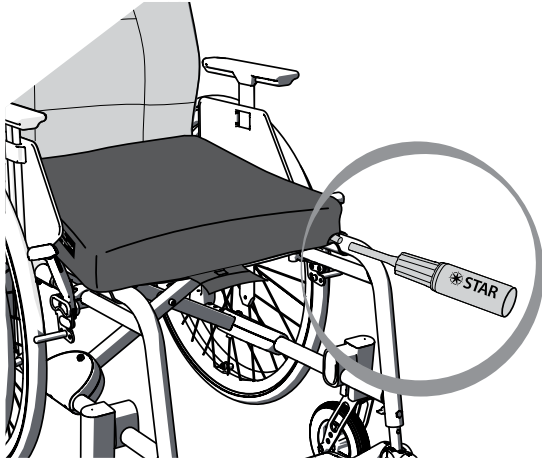

2

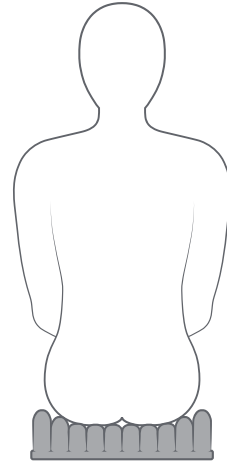

3

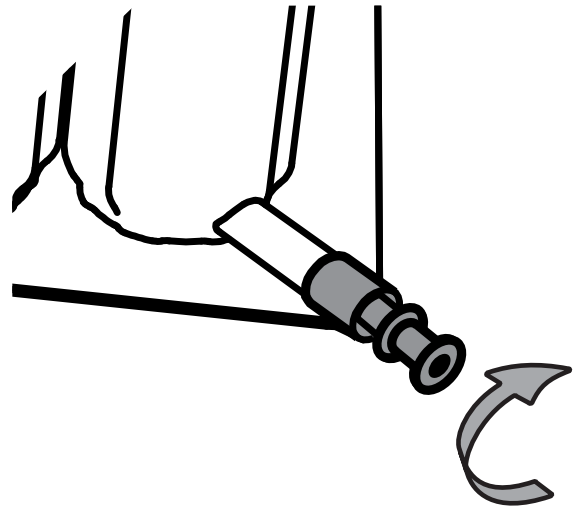
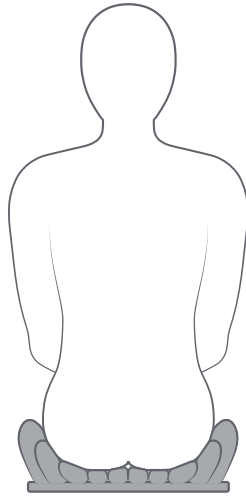
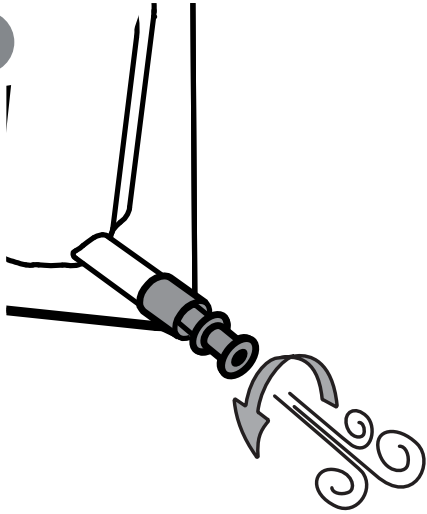

4

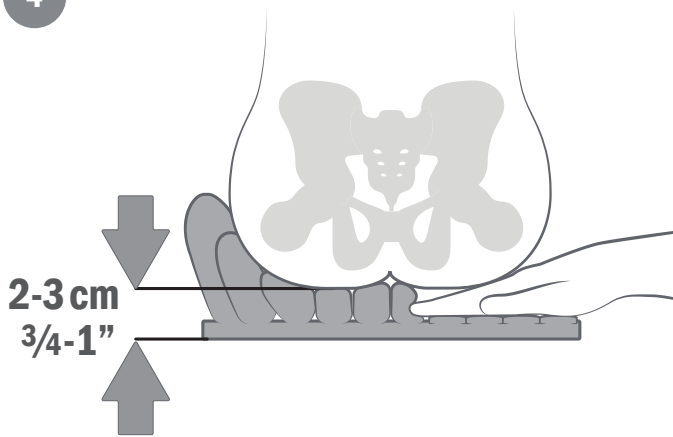

5

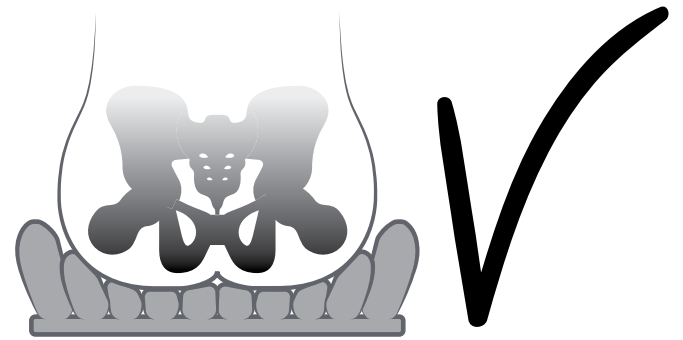

G

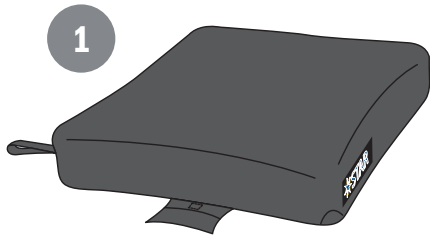

H

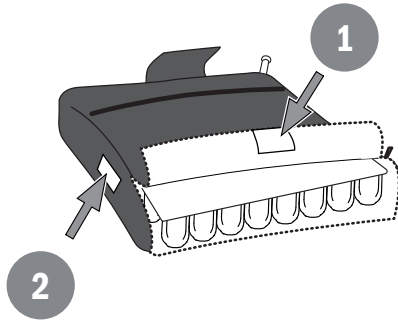

I

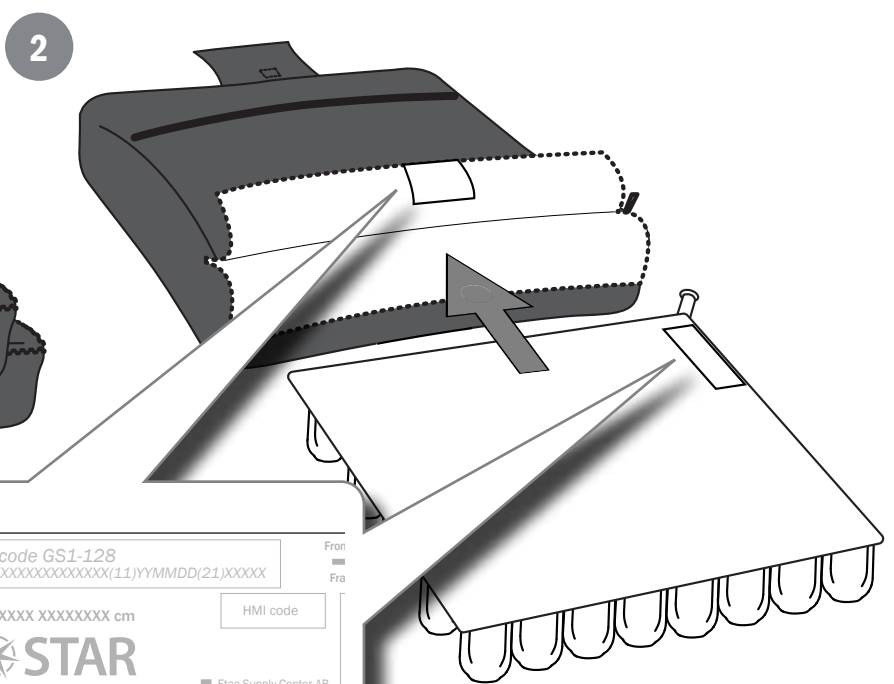
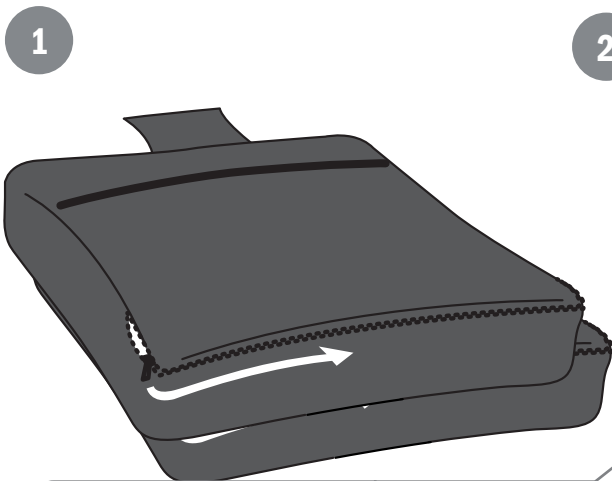

<p>STAR by Etac</p>	
REF	XXXXX-XX
Name: XXXXXXXXX	
Fits cushion: H XX W XX D XX cm H XX W XX D XX inch	
UDI	Bar code
<p>CE-mark is valid for the complete cushion.</p>	
Back/Down Bak/Ner	Bar code GS1-128 (01)XXXXXXXXXXXX(11)YYMMDD(21)XXXX
REF	XXXXXXXX-X -XXXXXXXX XXXXXXXX cm
SN	XXXXXX
<p>STAR by Etac</p>	
Size (in): XX x XX x XX	Size (cm): XX x XX x XX
Weight Limit: None if Sized to User	Bottom
Etac Supply Center AB Långatan 12 SE 334 33 Anderstorp YYYY-MM	

3

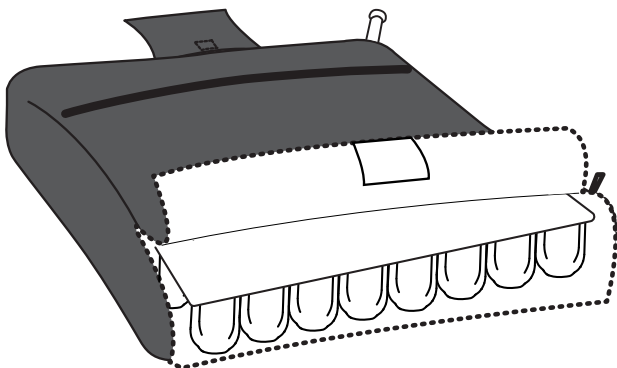

4

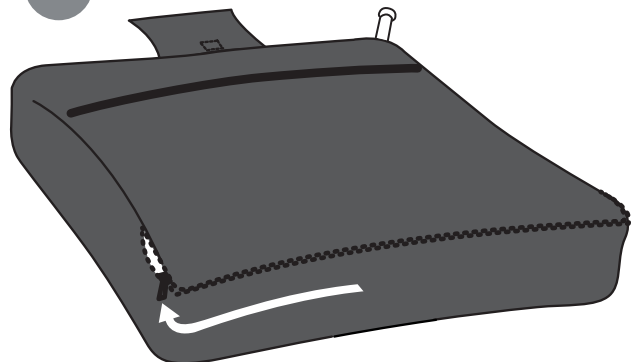

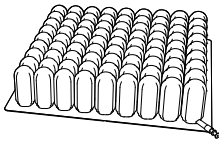

Star StabilAir (SA3)	75 mm (3")	1.54 kg (3.4 lbs) *
Star StabilAir (SA4)	100 mm (4")	1.86 kg (4.1 lbs) *
Star Standard Air (SCS)	50 mm (2")	0.98 kg (2.15 lbs) *
Star Standard Air (MC)	75 mm (3")	1.25 kg (2.75 lbs) *
Star Standard Air (SC)	100 mm (4")	1.52 kg (3.35 lbs) *

* en 9 x 9 air cells cushions / sv dynor med 9 x 9 luftceller / no 9 x 9 luftcelleputer / da 9 x 9 luftcellepuder / de 9 x 9 Luftzellenkissen / fi 9 x 9 ilmakennotyyntyä / fr Coussins à cellules pneumatiques 9 x 9 / nl 9 x 9 luchtcelkussens / it Cuscini a celle d'aria 9 x 9 / es Cojines de celdas de aire 9 x 9 / pt 9 x 9 almofadas de células de ar / hr 9 x 9 jastuka sa zračnim ćelijama / pl Poduszki z komorami powietrznymi w układzie 9 x 9 / is Sessur með 9 x 9 lofthólfum / sl Blazine z 9 x 9 zračnimi celicami

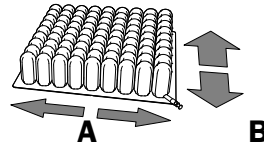
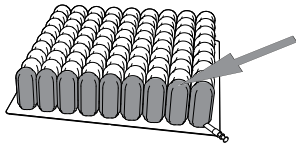

	A	B
5	260 mm / 10.25"	260 mm / 10.25"
6	300 mm / 11.75"	300 mm / 11.75"
7	340 mm / 13.5"	340 mm / 13.5"
8	390 mm / 15.5"	390 mm / 15.5"
9	440 mm / 17.25"	440 mm / 17.25"
10	490 mm / 19.25"	490 mm / 19.25"
11	530 mm / 21"	530 mm / 21"

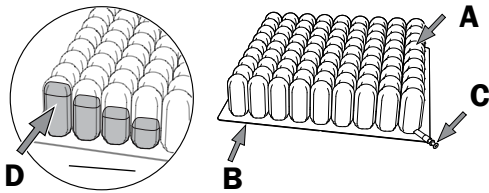

	Standard cover	Incontinence cover
en	Polyester/Polyurethane	Polyamide
sv	Polyester/Polyuretan	Polyamid
no	Polyester/polyuretan	Polyamid
da	Polyester/polyuretan	Polyamid
de	Polyester/Polyurethan	Polyamid
fi	Polyesteri/polyuretaani	Polyamidi
fr	Polyester/Polyuréthane	Polyamide
nl	Polyester/polyurethaan	Polyamide
it	Poliestere/poliuretano	Poliammide
es	Poliéster/poliuretano	Poliamida
pt	Poliéster/poliuretano	Poliamida
hr	Poliester/poliuretan	Poliamid
pl	Poliester/poliuretan	Poliamid
is	Pólýester/Pólýúretan	Pólýamíð
sl	poliester/poliuretan	poliamid

en	A. Chloroprene B. Polyurethane C. Electroplated brass D. Polyurethane foam*
sv	A. Kloropren B. Polyuretan C. Galvaniserad mässing D. Polyuretan*
no	A. Kloropren B. Polyuretan C. Galvanisert messing D. Polyuretan*
da	A. Chloropren B. Polyuretan C. Galvaniseret messing D. Polyuretan*
de	A. Chloropren B. Polyurethan C. Galvanisiertes Messing D. Polyurethan*
fi	A. Kloropreeni B. Polyuretaani C. Galvanoitu messinki D. Polyuretaani*
fr	A. Chloroprène B. Polyuréthane C. Laiton galvanisé D. Polyuréthane*
nl	A. Chloropreen B. Polyurethaan C. Gegalvaniseerd messing D. Polyurethaan*
it	A. Cloroprene B. Poliuretano C. Ottone galvanizzato D. Poliuretano*
es	A. Cloropreno B. Poliuretano C. Latón galvanizado D. Poliuretano*
pt	A. Cloropreno B. Poliuretano C. Latão galvanizado D. Poliuretano*
hr	A. Kloropren B. Poliuretan C. Galvanizirana mjed D. Poliuretan*
pl	A. Chloropren B. Poliuretan C. Mosiądz galvanizowany D. Pianka poliuretanowa*
is	A. Klóropren B. Pólýúretan C. Rafhúðaður kopar D. Pólýúretanfraud*
sl	A. kloropren B. poliuretan C. Galvanizirana medenina D. poliuretanska pena*

*StabilAir